

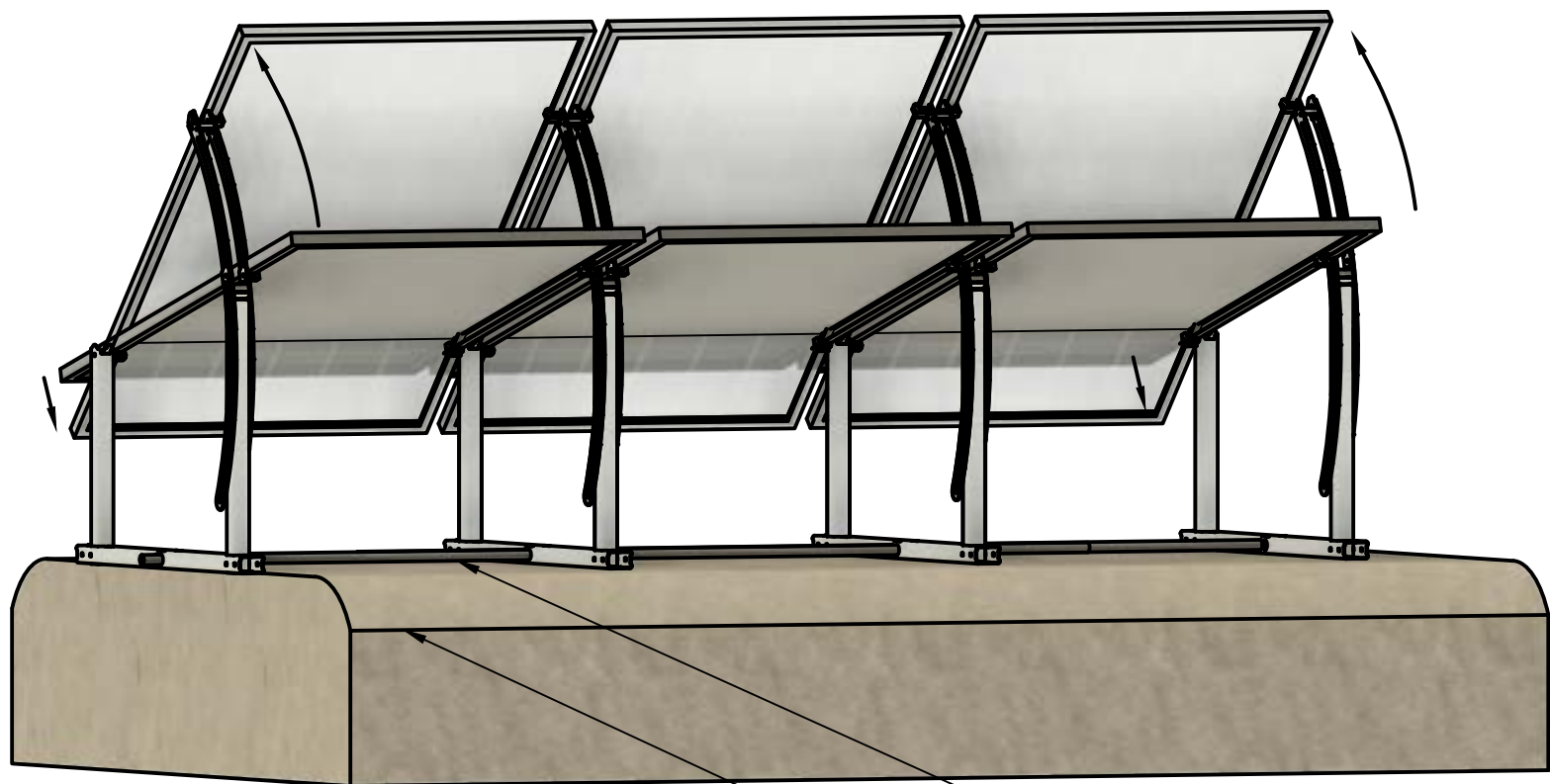

Height off the ground and space between frames will vary based on module size and adjustment angle.
(Solar module size represented is 44.7"x67.8")



1" EMT Conduit Pipe not provided

6 inch compacted road base fill material recommended for elevated solar array base.

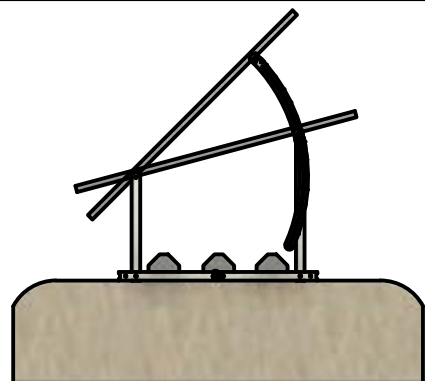

Base Frame Ballasted:
Three 175lb curb stop ballasts per solar module.
525lbs minimum per solar module for 70-80 mph windspeed at 45 degree angle.
(No stakes required)

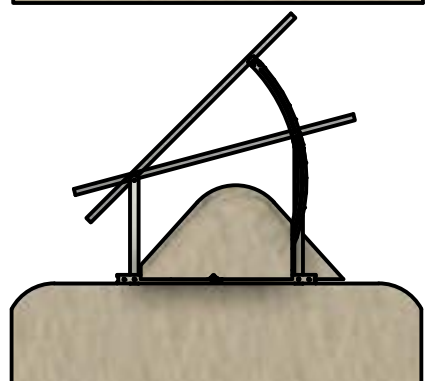

IR EarthBallast™ System:
22in fill to top of mound. 1200lbs minimum per solar module.
Center of mound 6" offset toward rear leg.
(3/4" Steel concrete forming stakes required at each end of base tube member)

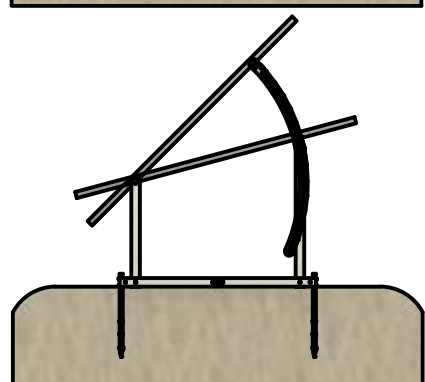

IR AnchorSpike™ System:
Two AnchorSpikes per frame section
Medium/high density compacted soil required.
(1000lb minimum uplift test per AnchorSpike.
Not compatible in regions with frost depths over 24 inches)

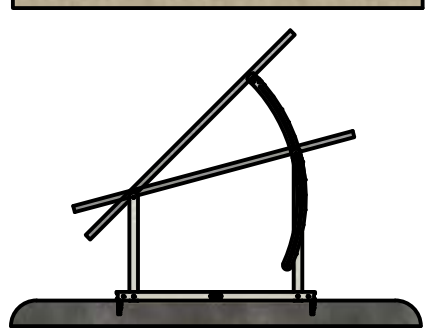

Base Frame Bolted:
Bolted to concrete footing, concrete ballast pad, or steel beam.
(1200lbs minimum per frame section)

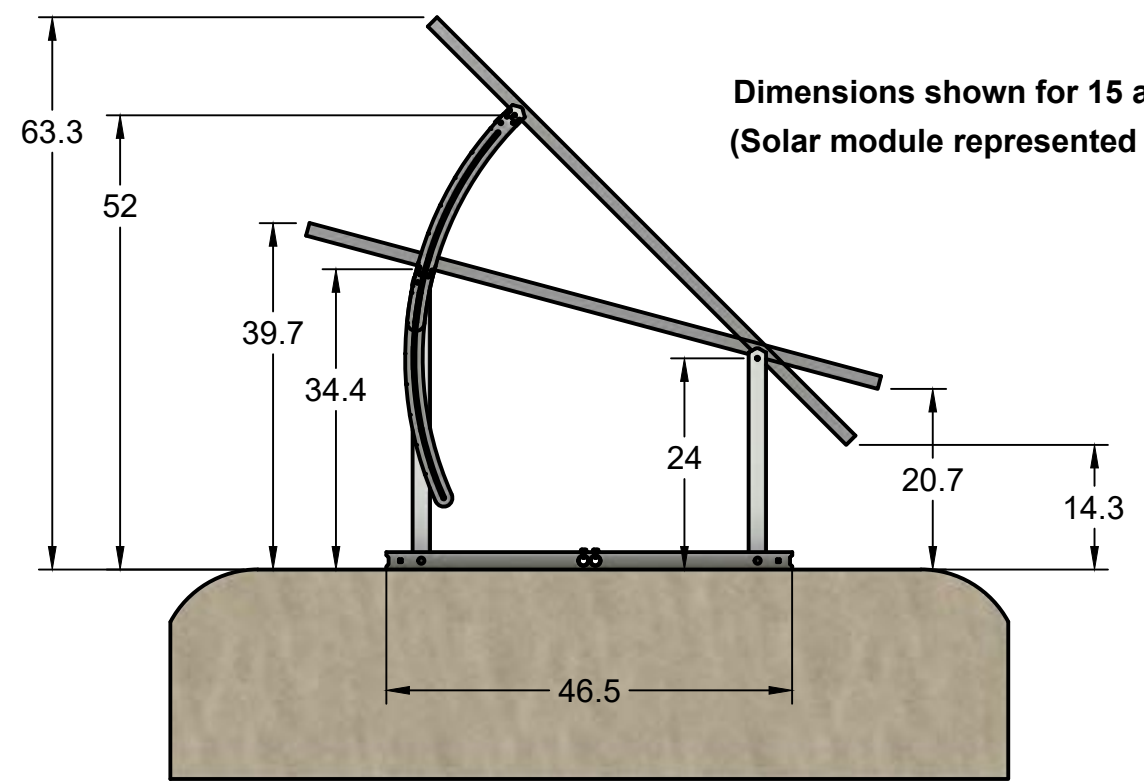

Dimensions shown for 15 and 45 degrees
(Solar module represented is 44.7"x67.8")

*Images shown at 15 and 45 degrees positions



PROJECT			
IntegraRack			
TITLE			
IR-45ASA Solar Racking System Data Sheet			
IR-45ASA1000			
APPROVED Paul Budge 7/29/2024	SIZE	CODE	DWG NO
CHECKED Paul Budge 7/29/2024	B		
DRAWN Jeff Glauser 7/29/2024	SCALE 1:20	WEIGHT 16lbs/frame section	SHEET 1/2
			REV



Maximum Snow Load for All Angles	
Module size up to 24 sqft	Module size up to 28 sqft
100 psf	65 psf

15 Degree Angle		
Maximum Wind Speed		
	Module size up to 24 sqft	Module size up to 28 sqft
Base Frame Ballasted	110 mph	100 mph
IR EarthBallast™	180 mph	150 mph
IR AnchorSpike™	180 mph	150 mph
Base Frame Bolted	200 mph	165 mph

20 Degree Angle		
Maximum Wind Speed		
	Module size up to 24 sqft	Module size up to 28 sqft
Base Frame Ballasted	105 mph	95 mph
IR EarthBallast™	170 mph	140 mph
IR AnchorSpike™	170 mph	140 mph
Base Frame Bolted	180 mph	150 mph

25 Degree Angle		
Maximum Wind Speed		
	Module size up to 24 sqft	Module size up to 28 sqft
Base Frame Ballasted	100 mph	90 mph
IR EarthBallast™	160 mph	130 mph
IR AnchorSpike™	160 mph	130 mph
Base Frame Bolted	165 mph	135 mph

30 Degree Angle		
Maximum Wind Speed		
	Module size up to 24 sqft	Module size up to 28 sqft
Base Frame Ballasted	95 mph	85 mph
IR EarthBallast™	150 mph	120 mph
IR AnchorSpike™	150 mph	120 mph
Base Frame Bolted	155 mph	125 mph

35 Degree Angle		
Maximum Wind Speed		
	Module size up to 24 sqft	Module size up to 28 sqft
Base Frame Ballasted	90 mph	80 mph
IR EarthBallast™	140 mph	110 mph
IR AnchorSpike™	140 mph	110 mph
Base Frame Bolted	145 mph	115 mph

40 Degree Angle		
Maximum Wind Speed		
	Module size up to 24 sqft	Module size up to 28 sqft
Base Frame Ballasted	85 mph	75 mph
IR EarthBallast™	130 mph	105 mph
IR AnchorSpike™	130 mph	105 mph
Base Frame Bolted	130 mph	105 mph

45 Degree Angle		
Maximum Wind Speed		
	Module size up to 24 sqft	Module size up to 28 sqft
Base Frame Ballasted	80 mph	70 mph
IR EarthBallast™	120 mph	100 mph
IR AnchorSpike™	120 mph	100 mph
Base Frame Bolted	120 mph	100 mph

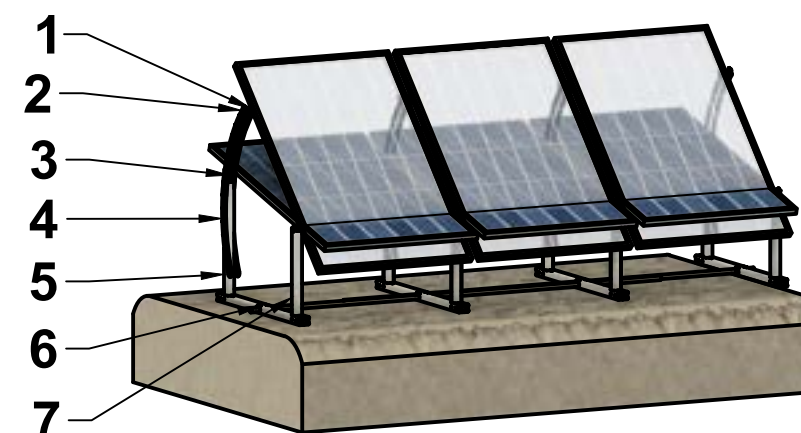

Parts List	
1	IR-F2FC0002
2	IRP-35SP1000-S
3	IRP-45ASAC0002-S
4	IRP-45ASAP0026-S
5	IRP-45ASAL1000-T
6	IRP-00BT1000-T
7	IRP-45ASAS1000-T



April 24, 2024
 Mr. Paul Budge
 Diversi-Tech Corp - IntegraRack
 PO Box 910758
 St. George, UT 84791

Subject: Simulated Wind Load, Snow Load, and Horizontal Racking Load Testing on IR-30 Solar Racking System.

Dear Mr. Budge,

Please find included our test reports for the simulated wind load (tensile load), snow load (compression load) and horizontal racking load tests of the IR-30 Solar Racking System performed on 3/20/2024 - 03/22/2024 in St. George, Utah.

The first simulated wind load test was performed on the IR-30 Solar Racking System Ground Frame that had two solar panels installed at a 30 ° angle and utilized the EarthBallast System. The load was applied via a crossbar connected to the solar panels which were then connected to the ground frame using the IR-F2 Under Mount Flange Clamp Bracket. The test was performed in two parts with the first part used ballast of two loose fill dirt loads from a skid steer, approximately 11 ft³ total volume, and then the second part used a total of three loads for a total volume of approximately 14 ft³. The IR-30 Solar Racking system was monitored for movement as the simulated wind load tensile force was applied. Test loads were measured using a calibrated Dyna-Link 2 Dynamometer (SN 100326, Cal. Date 10/13/2023). Test run details are shown in the table below.

SIMULATED WIND LOAD (TENSILE UPLIFT) FORCE INSPECTION DETAILS					
TEST NO.	BALLAST DETAILS		VISUAL OBSERVATIONS		
	SIZE (LxWxH) (in.)	CALCULATED WEIGHT (lbf)	UPLIFT TENSILE FORCE AT INITIAL FRAME MOVEMENT (lbf)	UPLIFT TENSILE FORCE AT FRAME AND BALLAST MOVEMENT (lbf)	MAX. FORCE REACHED (lbf)
1	96 in. x 18 in. x 11 in. (11 CF)	1100 lbf (2 skid steer buckets)	800	880	1045
2	92 in. x 42 in. x 14 in. (14 CF)	1400 lbf (3 skid steer buckets)	965	1065	1235

The horizontal racking load test was performed on the same IR-30 Solar Racking System Ground Frame that had two solar panels installed at a 30 ° angle and utilized the EarthBallast System and three loads of loose fill dirt ballast. A lifting strap was used to wrap around the panel and run parallel to the frame in order to apply the horizontal racking force. The system was monitored for movement as the simulated load was applied and the maximum load was recorded. The system held the load and no damage or permanent deformation was noted as detailed in the test observations table below.

SIMULATED HORIZONTAL RACKING FORCE INSPECTION DETAILS				
TEST NO.	BALLAST DETAILS		MAX. HORIZONTAL FORCE (lbf)	OBSERVATIONS
	SIZE (LxWxH) (in.)	WEIGHT (lbf)		
1	90 in. x 42 in. x 14 in. (14 CF)	~ 1400 lbf (3 skid steer buckets)	645	Test was stopped at 645 lbf. No damage or movement was visually noted.

The simulated snow load test was performed on a IR-30 Solar Racking System Ground Frame that was installed with two

short uprights so that the solar panel would be held parallel to the ground. The solar panel was attached to the ground frame using the IR-F2 Under Mount Flange Clamp Bracket. The load was applied using a large water tank that weighed 2410 lbf. The weight was recorded using the calibrated Dyna-Link 2 Dynamometer (SN 100326, Cal. Date 10/13/2023). The load was set on the frame and left overnight. The following day the load was increased by adding a total of twelve 5 gallon water jugs. The jugs were filled and weigh approximately 45 lbf per jug for a total weight of 2950 lbf. The frame held all loads and visual observations of the frame and components were recorded and shown in the table below.

SIMULATED SNOW LOAD (COMPRESSIVE LOAD) INSPECTION DETAILS			
	COMPRESSIVE FORCE		OBSERVATIONS
	DESCRIPTION	WEIGHT (lbf)	
1	Large water tank	2410	Solar panel held load overnight (> 10 h).
2	Large water tank + (12) five gallon jugs	2950	Solar panel held load, ~ 10 -15 minutes under observation. Slight deflections noted under load (See Photos). Minor permanent deformation noted after load removal (See Photos). The alignment tabs in the vertical uprights were no longer flat with the uprights.

The final simulated wind load test was performed on the IR-30 Solar Racking System Ground Frame that had two solar panels installed at a 30 ° angle and utilized the small IR AnchorSpikes and no earth ballast. The load was applied via a crossbar connected to the solar panels which were then connected to the ground frame using the IR-F2 Under Mount Flange Clamp Bracket. The load was applied until failure of a solar panel at 2385 lbf. Visual observations noted that the frame had visibly moved and shifted forward initially at 1500 lbf but continued to hold load as detailed in the table below.

SIMULATED WIND LOAD (TENSILE UPLIFT) FORCE INSPECTION DETAILS		
TEST NO.	MAX. FORCE (lbf)	OBSERVATIONS
1	2385	At 1500 lbf the frame visibly shifted and started to roll forward. At 2385 lbf one of the solar panels failed and shattered (Photos 7-9). The frame and brackets holding the solar panel kept it in place and were permanently deformed. The aluminum tube upright had bent forward and outward causing the seam of the tube to tear and it allowed the through bolt to come free. Two mounting brackets permanently deformed and there was additional permanent deformation in the base frame (Photos 10-15)

Test reports with additional details, photos, and data have been attached.

Respectfully submitted,
PHOENIX NATIONAL LABORATORIES, INC.

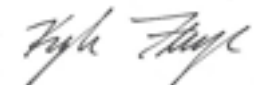

Kyle Fleege, P.E.
 Project Manager / Mechanical Engineer
 Phoenix National Laboratories
 Ph: 1.602.431.8887
 kyle@pnltest.com
 www.pnltest.com



INSPECTION AND TEST REPORT

PNL REF. # 26-240383 S.O. # 001 INDEX 03

INSPECTION DATE 03/20/2024

IR-30 Ground Frame w/ EarthBallast: Simulated Wind Load

CLIENT		CLIENT PROJECT REFERENCE		CLIENT ORDER NO.	
IntegraRack		IR-30 Solar Racking System w/ Earth Ballast - Simulated Wind		per S.A.	
SAMPLE DESCRIPTION			TEST LOCATION		TECHNICIANS
IR-30 Solar Racking System w/ Earth Ballast			St. George, UT		Weston A.
TEST CONDITIONS & EQUIPMENT INFORMATION					
TEMPERATURE:	65 °F ± 10 °F		HUMIDITY:	30% ± 10%	
LOAD TYPE:	Simulated Wind Load - Tensile / Uplift		TEST LOAD:	Record	
EQUIPMENT TYPE:	Dyna-Link 2 Dynamometer MSI-7300RF	S/N & CALIBRATION DATE:	S/N 100326; CAL 10/13/2023		
SKID STEER MODEL:	Kubota SSV65				
TEST SPECIMEN & COMPONENT INFORMATION					
TEST SPECIMEN:	IR-30 Solar Racking System		ID NO.:	IR-30RF1000	
SOLAR PANELS SIZE:	39.25 in. x 66 in.		TEST SPECIMEN AREA:	17.989 ft ²	
SYSTEM COMPONENT 1:	IRF2 Under Mount Flange Clamp Bracket		PART NO. 1:	IR-FCCM0500	
SYSTEM COMPONENT 2:	Large IR-30 Frame Upright		PART NO. 2:	IRP-30LL1000-T	
SYSTEM COMPONENT 3:	Small IR-30 Frame Upright		PART NO. 3:	IRP-30SL1000-T	
SYSTEM COMPONENT 4:	IR-30 Base Tube		PART NO. 4:	IRP-30BT1000-T	
SYSTEM COMPONENT 5:	Connecting Rod		PART NO. 5:	None - 1" EMT pipe	
SIMULATED WIND LOAD (TENSILE UPLIFT FORCE) TEST PROCEDURE/DESCRIPTION					
<p>The IR-30 Solar Racking System Ground Frame was installed with two solar panels and the IR EarthBallast System. The system utilizes a mesh that is epoxied to the frame which is then loaded with dirt (ballast) that supports and holds down the frame (Photo 3). The system was tested with 2 Kubota SSV75 skid steer loads of dirt loaded for Test 1 and 3 loads for Test 2. Load was applied via a red crossbar that was fastened to the edges of the solar panel frames that was connected to the ground frame via the IRF2 Under Mount Flange Clamp Bracket. The skid steer dirt loads were estimated at approximately 500 lbf each using an estimated 100 lb/ft³ for the density of the soil. The actual density of the soil is unknown.</p> <p>The solar panels were set at an approximate 30° angle. The tensile force was applied upwards and away, at a perpendicular angle from the solar panels using the skid steer (Photo 4). Load was monitored with the digital dynamometer. Load was recorded when an initial shift of the solar panel frame was noted and when the shift was large enough to cause visual changes to the frame and in the ballast surface (Photos 5-13).</p>					
SIMULATED WIND LOAD (TENSILE UPLIFT) FORCE INSPECTION DETAILS					
TEST NO.	BALLAST DETAILS		VISUAL OBSERVATIONS		
	SIZE (LxWxH) (in.)	CALCULATED WEIGHT (lbf)	UPLIFT TENSILE FORCE AT INITIAL FRAME MOVEMENT (lbf)	UPLIFT TENSILE FORCE AT FRAME AND BALLAST MOVEMENT (lbf)	MAX. FORCE REACHED (lbf)
1	96 in. x 18 in. x 11 in. (11 CF)	1100 lbf (2 skid steer buckets)	800	880	1045
2	92 in. x 42 in. x 14 in. (14 CF)	1400 lbf (3 skid steer buckets)	965	1065	1235

TECHNICIAN Weston A.

REVIEWED BY Kyle Flagg

CLIENT	CLIENT PROJECT REFERENCE	CLIENT ORDER NO.
IntegraRack	IR-30 Solar Racking System w/ Earth Ballast - Simulated Wind	per S.A.
SAMPLE DESCRIPTION	TEST LOCATION	TECHNICIANS
IR-30 Solar Racking System w/ Earth Ballast	St. George, UT	Weston A.

PHOTOS



PHOTO 1: Dynamometer used to record loads



PHOTO 2: Dynamometer ID label



PHOTO 3: Test setup - IR-30 Solar Racking System with red test cross frame



PHOTO 4: Test setup with dynamometer and chains connected



PHOTO 5: Test 1 - Evidence of ballast shift



PHOTO 6: Test 1 - Load at ballast shift



PHOTO 7: Test 1 - Max load

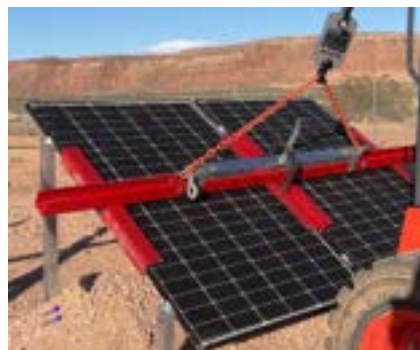

PHOTO 8: Test 2 - Evidence of ballast shift

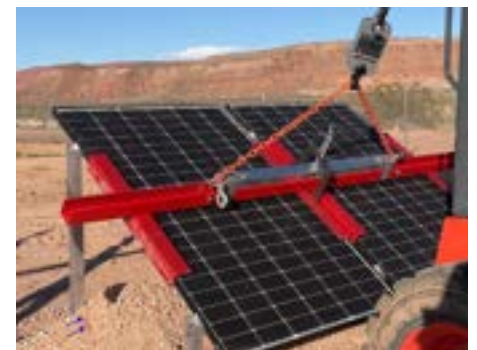

PHOTO 9: Test 2 - Evidence of ballast shift

CLIENT	CLIENT PROJECT REFERENCE	CLIENT ORDER NO.
IntegraRack	IR-30 Solar Racking System w/ Earth Ballast - Uplift Force	per S.A.
SAMPLE DESCRIPTION	TEST LOCATION	TECHNICIANS
IR-30 Solar Racking System w/ Earth Ballast	St. George, UT	Weston A.

PHOTOS



PHOTO 10: Test 2 - Load at ballast shift



PHOTO 11: Test 2 - Max load



PHOTO 12: Test 2 - Max load



PHOTO 13: Ballast after completion of testing



PHOTO 14: Ballast and frame after completion of testing

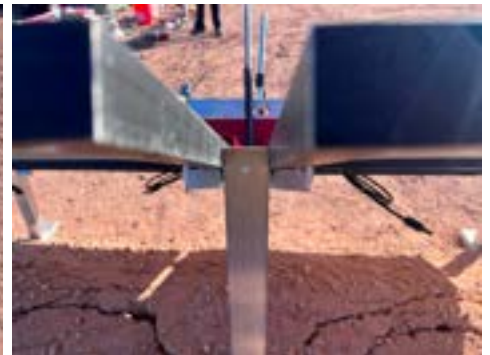

PHOTO 13: IR-F2 Clamp bracket after completion of testing

INSPECTION AND TEST REPORT

PNL REF. # 26-240383 S.O. # 001 INDEX 03

INSPECTION DATE 03/20/2024

IR-30 Ground Frame w/ EarthBallast: Horizontal Racking Load

CLIENT		CLIENT PROJECT REFERENCE		CLIENT ORDER NO.	
IntegraRack		IR-30 Solar Racking System w/ Earth Ballast - Horizontal Racking		per S.A.	
SAMPLE DESCRIPTION			TEST LOCATION		TECHNICIANS
IR-30 Solar Racking System w/ Earth Ballast			St. George, UT		Weston A.
TEST CONDITIONS & EQUIPMENT INFORMATION					
TEMPERATURE:	65 °F ± 10 °F		HUMIDITY:	30% ± 10%	
LOAD TYPE:	Horizontal Racking Load		TEST LOAD:	Record	
EQUIPMENT TYPE:	Dyna-Link 2 Dynamometer MSI-7300RF	S/N & CALIBRATION DATE:	S/N 100326; CAL 10/13/2023		
SKID STEER MODEL:	Kubota SSV65				
TEST SPECIMEN & COMPONENT INFORMATION					
TEST SPECIMEN:	IR-30 Solar Racking System		ID NO.:	IR-30RF1000	
SOLAR PANELS SIZE:	39.25 in. x 66 in.		TEST SPECIMEN AREA:	17.989 ft ²	
SYSTEM COMPONENT 1:	IRF2 Under Mount Flange Clamp Bracket		PART NO. 1:	IR-FCCM0500	
SYSTEM COMPONENT 2:	Large IR-30 Frame Upright		PART NO. 2:	IRP-30LL1000-T	
SYSTEM COMPONENT 3:	Small IR-30 Frame Upright		PART NO. 3:	IRP-30SL1000-T	
SYSTEM COMPONENT 4:	IR-30 Base Tube		PART NO. 4:	IRP-30BT1000-T	
SYSTEM COMPONENT 5:	Connecting Rod		PART NO. 5:	None - 1" EMT pipe	
HORIZONTAL RACKING FORCE TEST PROCEDURE/DESCRIPTION					
<p>The IR-30 Solar Racking System Ground Frame was installed with the IR EarthBallast System and two solar panels. The EarthBallast system utilizes a mesh that is epoxied to the frame which is then loaded with loose dirt fill (ballast) that supports and holds down the frame. The horizontal load test was performed after the vertical uplift tensile load test. The system was tested with 3 loads of dirt from a Kubota SSV75 skid steer. The skid steer dirt loads were estimated at ~ 500 lbf each using an estimate of 100 lb/ft³ for the density of soil. A lifting strap was wrapped around the panel lengthwise and run parallel to the frame in order to apply a horizontal force to the system (Photos). Force was applied using the skid steer and load was monitored with the digital dynamometer. The test was stopped at a load of 645 lbf. No movement or damage was visually noted during or after the test.</p>					
HORIZONTAL RACKING FORCE INSPECTION DETAILS					
TEST NO.	BALLAST DETAILS		MAX. HORIZONTAL FORCE (lbf)	OBSERVATIONS	
	SIZE (LxWxH) (in.)	WEIGHT (lbf)			
1	90 in. x 42 in. x 14 in. (14 CF)	~ 1400 lbf (3 skid steer buckets)	645	Test was stopped at 645 lbf. No damage or movement was visually noted.	

TECHNICIAN



REVIEWED BY

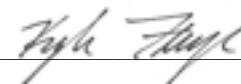

CLIENT	CLIENT PROJECT REFERENCE	CLIENT ORDER NO.
IntegraRack	IR-30 Solar Racking System w/ Earth Ballast - Horizontal Racking	per S.A.
SAMPLE DESCRIPTION	TEST LOCATION	TECHNICIANS
IR-30 Solar Racking System w/ Earth Ballast	St. George, UT	Weston A.

PHOTOS



PHOTO 1: Horizontal force test setup



PHOTO 2: Horizontal force test setup



PHOTO 3: Horizontal force test setup



Photo 4: Horizontal force test at max load



Photo 4: Horizontal force test max load

CLIENT		CLIENT PROJECT REFERENCE		CLIENT ORDER NO.
IntegraRack		IR-30 Solar Racking System - Simulated Snow Load		pefr S.A.
SAMPLE DESCRIPTION			TEST LOCATION	TECHNICIANS
IR-30 Solar Racking System w/ 1 solar panel			St. George, UT	Weston A.
TEST CONDITIONS & EQUIPMENT INFORMATION				
TEMPERATURE:	65 °F ± 10 °F		HUMIDITY:	30% ± 10%
LOAD TYPE:	Simulated Snow Load - Compressive		TEST LOAD:	Record
EQUIPMENT TYPE:	Dyna-Link 2 Dynamometer MSI-7300RF	S/N & CALIBRATION DATE:	S/N 100326; CAL 10/13/2023	
WATER TANK WEIGHT:	2410 lbf			
TEST SPECIMEN & COMPONENT INFORMATION				
TEST SPECIMEN:	IR-30 Solar Racking System		ID NO.:	IR-30RF1000
SOLAR PANELS SIZE:	39.25 in. x 66 in.		TEST SPECIMEN AREA:	17.989 ft ²
SYSTEM COMPONENT 1:	IRF2 Under Mount Flange Clamp Bracket	PART NO. 1:	IR-FCCM0500	
SYSTEM COMPONENT 2:	Small IR-30 Frame Upright	PART NO. 2:	IRP-30SL1000-T	
SYSTEM COMPONENT 3:	Small IR-30 Frame Upright	PART NO. 3:	IRP-30SL1000-T	
SYSTEM COMPONENT 4:	IR-30 Base Tube	PART NO. 4:	IRP-30BT1000-T	
SYSTEM COMPONENT 5:	Connecting Rod	PART NO. 5:	None - 1" EMT pipe	
SIMULATED SNOW LOAD (COMPRESSIVE LOAD) TEST PROCEDURE/DESCRIPTION				
<p>The IR-30 Solar Racking System Ground Frame was installed using only the short uprights so that the solar panel, size 39-1/4 in.x 66 in., would be flat and parallel to the ground (Photo). Solar panel frames were connected to the ground frame via the IRF2 Under Mount Flange Clamp Bracket. The 1st part of the test was placing the large water tank directly on top of the solar panels and leaving it overnight. Two aluminum rectangular tubes were placed along the longitudinal edge of the solar panel for the water tank to be placed on so that the load was distributed to both sides of the frame (Photo). The 2nd part of the test involved adding 12 additional 5 gallon water jugs. The same 5 gallon jugs had been filled with water and weighed on PNL's calibrated universal test machines for previous tests (See PNL Report 26-231261.001 (dated 10/13/2023) for Compression Load Test) and had an average weight of 45.31 lbf so an average weight of 45 lbf was assumed for the full water jugs.</p>				
SIMULATED SNOW LOAD (COMPRESSIVE LOAD) INSPECTION DETAILS				
	COMPRESSIVE FORCE		OBSERVATIONS	
	DESCRIPTION	WEIGHT (lbf)		
1	Large water tank	2410	Solar panel held load overnight (> 10 h).	
2	Large water tank + (12) five gallon jugs	2950	Solar panel held load, ~ 10 -15 minutes under observation. Slight deflections noted under load (See Photos). Minor permanent deformation noted after load removal (See Photos). The alignment tabs in the vertical uprights were no longer flat with the uprights.	

TECHNICIAN Weston A.

REVIEWED BY Kyle Floyd

CLIENT	CLIENT PROJECT REFERENCE	CLIENT ORDER NO.
IntegraRack	IR-30 Solar Racking System - Snow Load / Compression Load	per S.A.
SAMPLE DESCRIPTION		TECHNICIANS
Horizontal Load Test on IR-30 Ground Frame Earth Ballast		Weston A.

PHOTOS

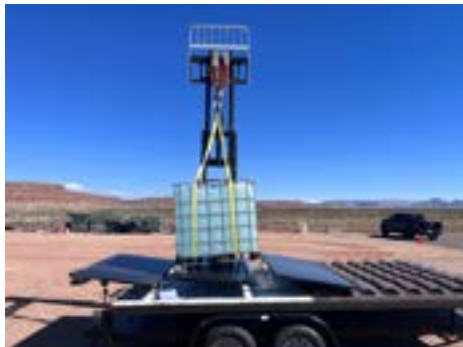

PHOTO 1: Weighing the large water tank



PHOTO 2: Large water tank weight



PHOTO 3: IR-30 Solar Racking System setup for test



PHOTO 4: Setting initial load



PHOTO 5: 2nd test - large tank + 12 five gallon jugs



PHOTO 6: Slight deflection under load



PHOTO 7: Slight deflections noted under load



PHOTO 8: Slight deflection noted under load



PHOTO 9: IR-30 system after compressive load tests

CLIENT	CLIENT PROJECT REFERENCE	CLIENT ORDER NO.
IntegraRack	IR-30 Solar Racking System - Snow Load / Compression Load	per S.A.
SAMPLE DESCRIPTION		TECHNICIANS
Horizontal Load Test on IR-30 Ground Frame Earth Ballast		Weston A.



PHOTO 10: Slight deformation after load removed



PHOTO 11: Slight deformation after load removed

INSPECTION AND TEST REPORT

PNL REF. # 26-240383 S.O. # 001 INDEX 03
INSPECTION DATE 03/21/2024
IR-30 Ground Frame w/ AnchorSpikes: Simulated Wind Load

CLIENT		CLIENT PROJECT REFERENCE				CLIENT ORDER NO.						
IntegraRack		IR-30 Solar Racking System w/ Anchor Spikes - Simulated Wind				per S.A.						
SAMPLE DESCRIPTION				TEST LOCATION		TECHNICIANS						
IR-30 Solar Racking System w/ AnchorSpikes				St. George, UT		Weston A.						
TEST CONDITIONS & EQUIPMENT INFORMATION												
TEMPERATURE:	65 °F ± 10 °F			HUMIDITY:	30% ± 10%							
LOAD TYPE:	Wind Load - Tensile / Uplift			TEST LOAD:	Record							
EQUIPMENT TYPE:	Dyna-Link 2 Dynamometer MSI-7300RF		S/N & CALIBRATION DATE:	S/N 100326; CAL 10/13/2023								
SKID STEER MODEL:	Kubota SSV65											
TEST SPECIMEN & COMPONENT INFORMATION												
TEST SPECIMEN:	IR-30 Solar Racking System			ID NO.:	IR-30RF1000							
SOLAR PANELS SIZE:	39.25 in. x 66 in.			TEST SPECIMEN AREA:	17.989 ft ²							
SYSTEM COMPONENT 1:	IRF2 Under Mount Flange Clamp Bracket			PART NO. 1:	IR-FCCM0500							
SYSTEM COMPONENT 2:	Large IR-30 Frame Upright			PART NO. 2:	IRP-30LL1000-T							
SYSTEM COMPONENT 3:	Small IR-30 Frame Upright			PART NO. 3:	IRP-30SL1000-T							
SYSTEM COMPONENT 4:	IR-30 Base Tube			PART NO. 4:	IRP-30BT1000-T							
SYSTEM COMPONENT 5:	Connecting Rod			PART NO. 5:	None - 1" EMT pipe							
SYSTEM COMPONENT 6:	IR AnchorSpikes - 19.5			PART NO. 6:	19.5 in. Barbed aluminum spikes							
SIMULATED WIND LOAD (TENSILE UPLIFT) FORCE TEST PROCEDURE/DESCRIPTION												
<p>The IR-30 Solar Racking System Ground Frame was installed using the small IR AnchorSpikes (Photo 3) and two part epoxy system. The AnchorSpoke installation consists of pounding the anchors into the ground, filling with the two part epoxy system, and then clamping the anchors to the frame with the built in clamps. Load was applied via a red crossbar that was fastened to the edges of the solar panel frames that was connected to the ground frame via the IRF2 Under Mount Flange Clamp Bracket.</p> <p>The solar panels were set at an approximate 30° angle. The tensile force was applied upwards and away, at a perpendicular angle from the solar panels using the skid steer (Photo 6). Displacement measurements were recorded before and after the load test at the anchor spike locations (Photos 4-5). Load was monitored with the digital dynamometer (Photos 1-2).</p>												
SIMULATED WIND LOAD (TENSILE UPLIFT) FORCE TEST ANCHORSPIKE AND FRAME DISPLACEMENT												
	Spike #1		Spike #2		Spike #3		Spike #4		Spike #5		Spike #6	
	Stickout (in.)	Ground to Frame (in.)	Stickout (in.)	Ground to Frame (in.)	Stickout (in.)	Ground to Frame (in.)	Stickout (in.)	Ground to Frame (in.)	Stickout (in.)	Ground to Frame (in.)	Stickout (in.)	Ground to Frame (in.)
Initial	2.188	1.250	2.250	1.125	2.625	1.000	2.250	0.500	2.000	1.625	2.438	1.063
Final	2.250	1.250	2.250	1.125	2.563	1.125	2.563	0.750	1.938	1.625	2.250	1.375
SIMULATED WIND LOAD (TENSILE UPLIFT) FORCE INSPECTION DETAILS												
TEST NO.	MAX. FORCE (lbf)		OBSERVATIONS									
1	2385		<p>At 1500 lbf the frame visibly shifted and started to roll forward.</p> <p>At 2385 lbf one of the solar panels failed and shattered (Photos 7-9). The frame and brackets holding the solar panel kept it in place and were permanently deformed. The aluminum tube upright had bent forward and outward causing the seam of the tube to tear and it allowed the through bolt to come free. Two mounting brackets permanently deformed and there was additional permanent deformation in the base frame (Photos 10-15)</p>									

TECHNICIAN Weston A.

REVIEWED BY Kyle Floyd

CLIENT	CLIENT PROJECT REFERENCE	CLIENT ORDER NO.
IntegraRack	IR-30 Solar Racking System w/ Anchor Spikes - Simulated Wind	per S.A.
SAMPLE DESCRIPTION	TEST LOCATION	TECHNICIANS
IR-30 Solar Racking System w/ AnchorSpikes	St. George, UT	Weston A.

PHOTOS



PHOTO 1: Dynamometer used to record loads



PHOTO 2: Dynamometer ID label



PHOTO 3: AnchorSpikes. The small AnchorSpike was used for setup in this test

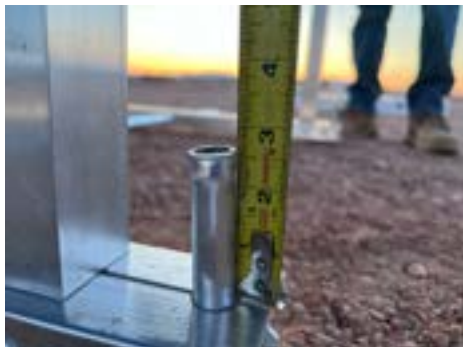

PHOTO 4: 'Stickout' measurement example at Spike #3



PHOTO 5: Ground to frame measurement example at Spike #3



PHOTO 6: Test setup - IR-30 Solar Racking System with AnchorSpikes



PHOTO 7: IR-30 Solar Racking System at max load



PHOTO 8: Closeup of max load, 2385 lbf



PHOTO 9: IR-30 Solar Racking System right after max load when panel failed

CLIENT	CLIENT PROJECT REFERENCE	CLIENT ORDER NO.
IntegraRack	IR-30 Solar Racking System w/ Anchor Spikes - Simulated Wind	per S.A.
SAMPLE DESCRIPTION	TEST LOCATION	TECHNICIANS
IR-30 Solar Racking System w/ AnchorSpikes	St. George, UT	Weston A.

PHOTOS



PHOTO 10: Solar panels after testing



PHOTO 11: Frame after testing



PHOTO 12: Middle brackets after testing



PHOTO 13: Bracket deformation after testing



PHOTO 14: Upright mount deformation after testing



PHOTO 15: Upright deformation after testing