

A

B

C

D

CHIKOUSA U2V GROUND MOUNT
20 DEGREE TILT ANGLE
PORTRAIT MODULE ORIENTATION

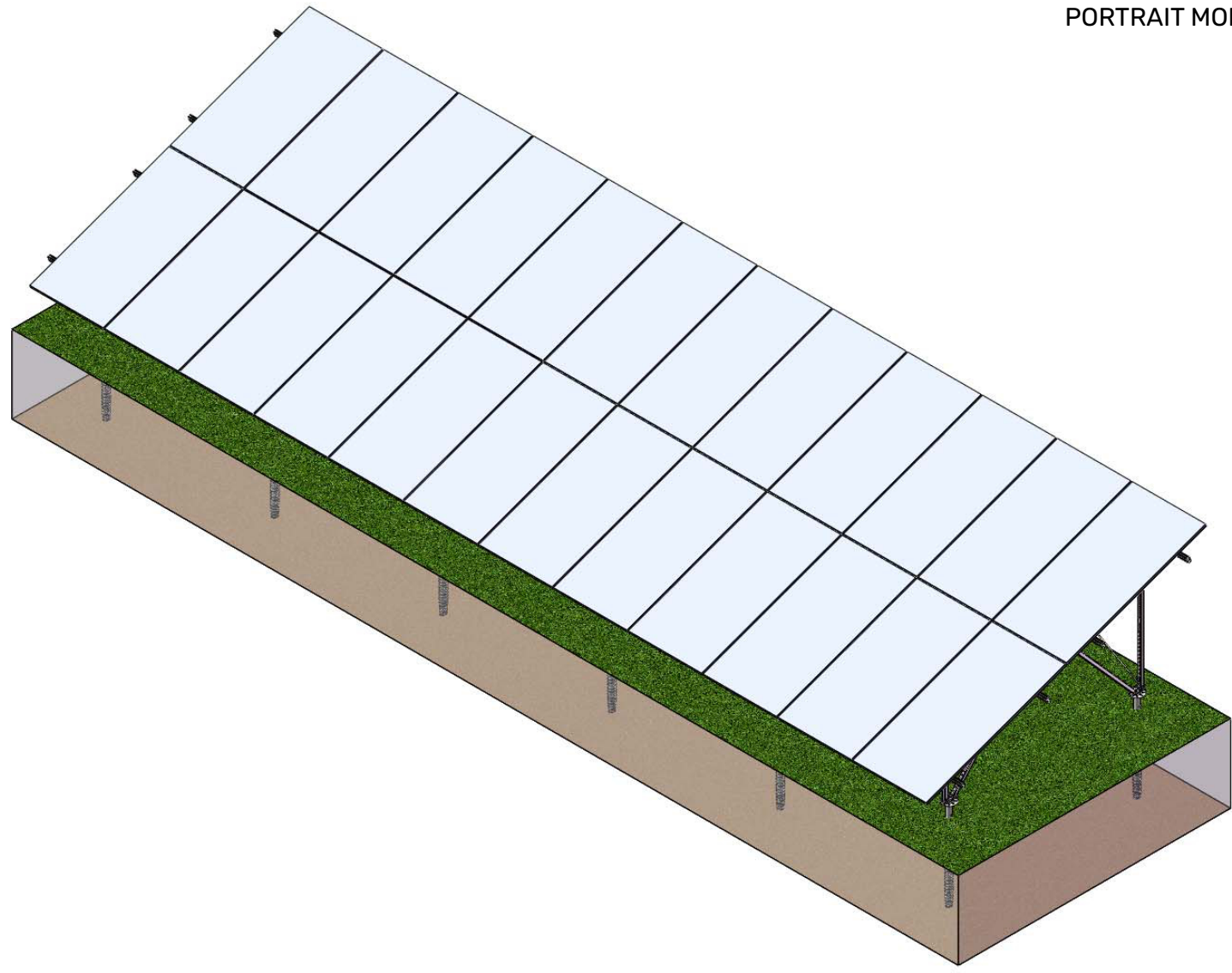

1	Mark	Modifivation	Modify by	Doc No.	Data	Des	J. Burton	231109
						Drw		
						Check		
						Craft		
						App		

CHIKOUSA

U2V
2X12-750-20°

View :

Rate

Page 1

A

B

C

D

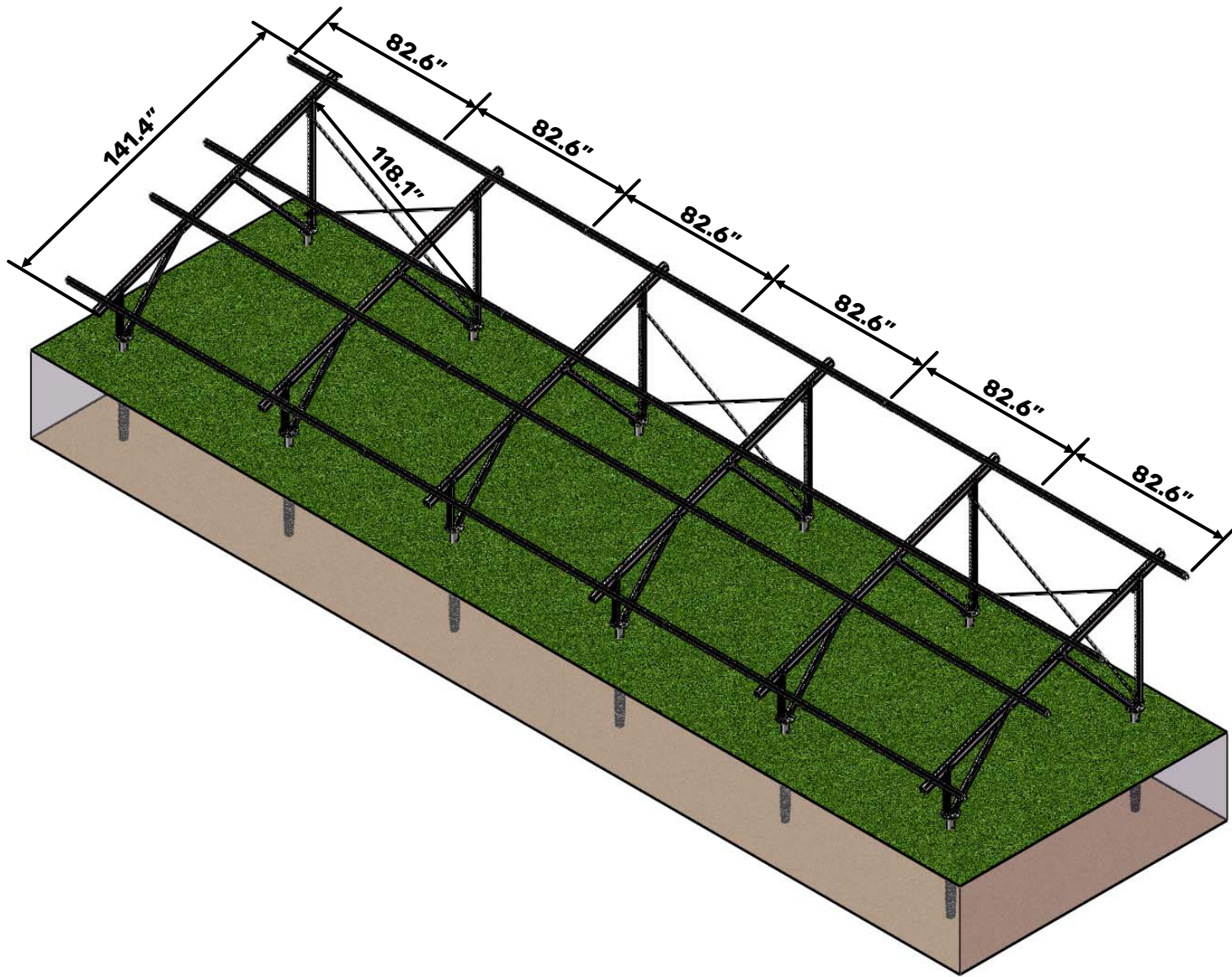

1	Mark	Modifivation	Modify by	Doc No.	Data	Des	J. Burton	231109
						Drw		
						Check		
						Craft		
						App		

CHIKOUSA

U2V

2X12-750-20°

View : 

Rate

Page 2

A

B

C

D

A

B

C

D

No	Description
1	Support Rack
2	End Clamp
3	Mid Clamp
4	Rail Splice Kit
5	Rail-4150
6	Strengthen Fix Kit
7	Strengthen Pipe
8	Ground Screw

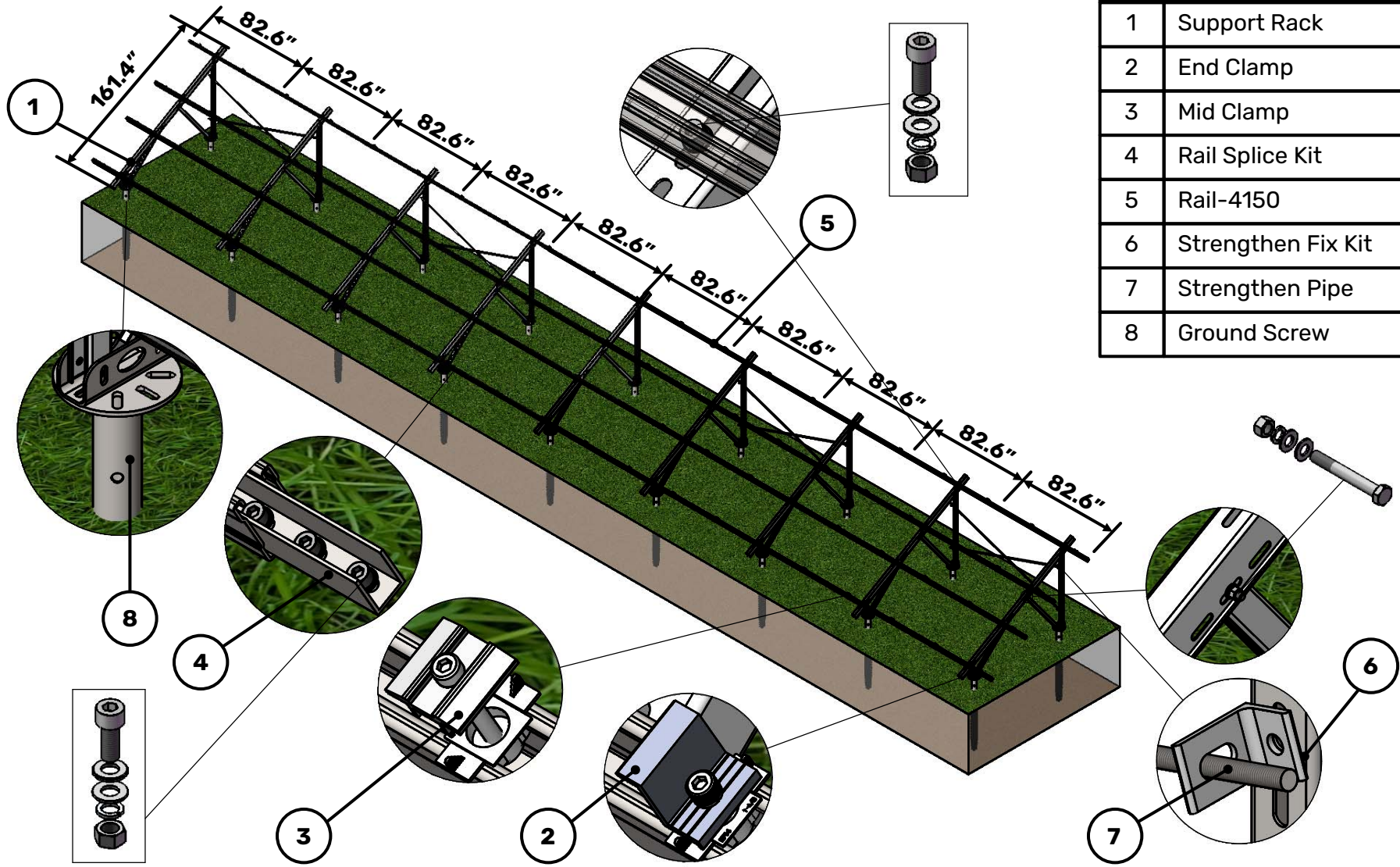

1	Mark	Modifivation	Modify by	Doc No.	Data	Des	J. Burton	231109
						Drw		
						Check		
						Craft		
						App		

CHIKOUSA

U2V
2*20-30° -405

View : Rate Page 3

A

B

C

D

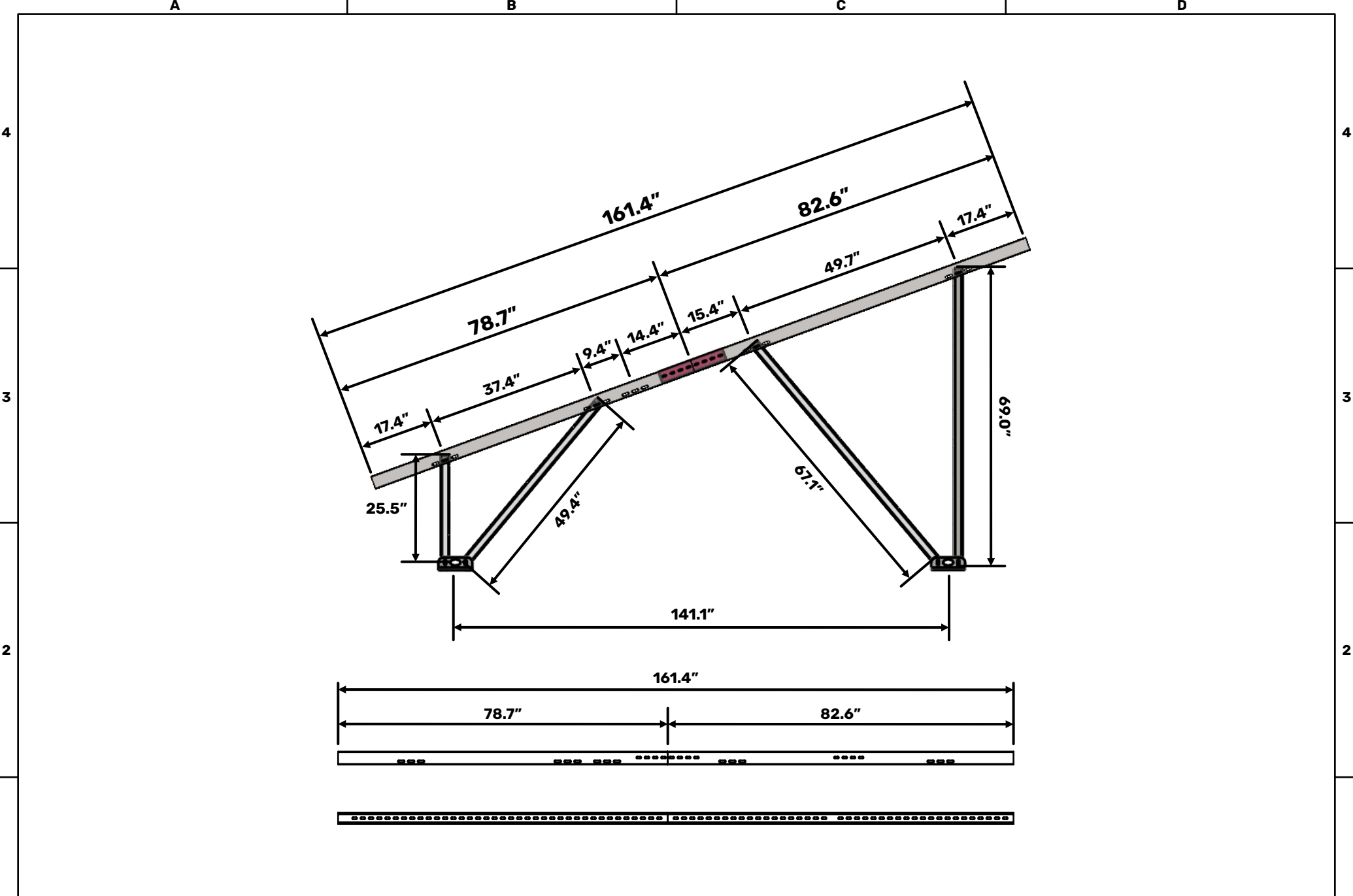

Mark	Modifivation	Modify by	Doc No.	Data	Des	J. Burton	231109	CHIKOUSA	
					Drw				
					Check				
					Craft				
					App			View :	Rate
									Page 4

A

B

C

D

4

4

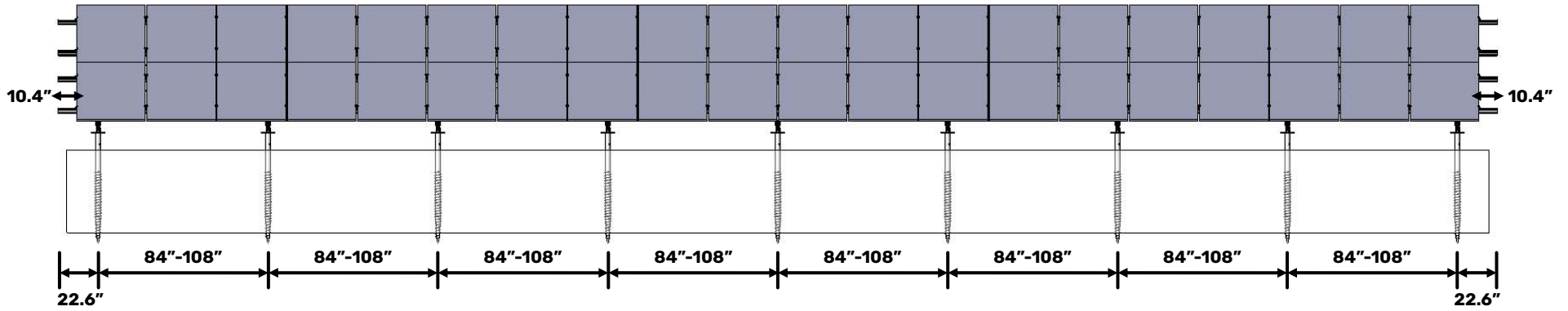

3

3

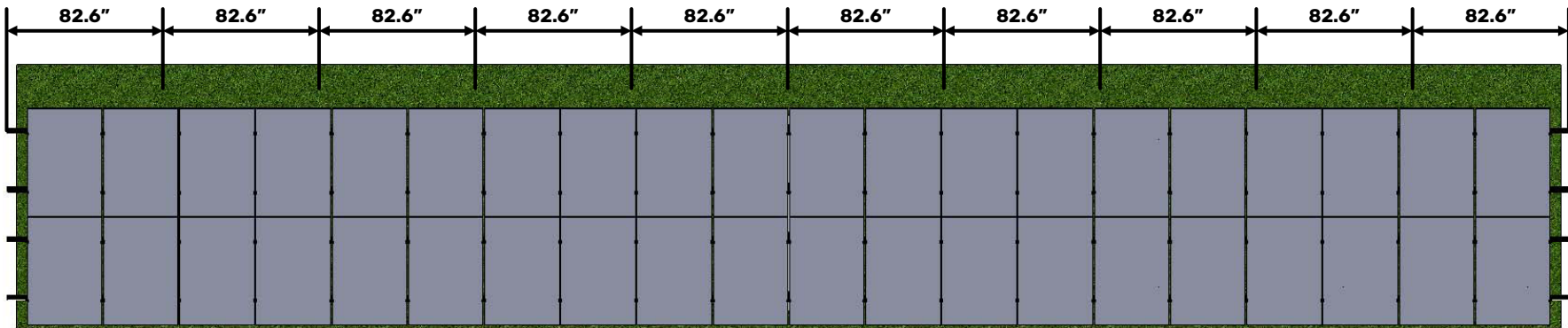

2

2

1

1

Mark	Modifivation	Modify by	Doc No.	Data	Des	J. Burton	231109
					Drw		
					Check		
					Craft		
					App		

CHIKOUSA

U2V

2*20-30° -405

View :

Rate

Page 5

A

B

C

D