

A

B

C

D

**CHIKOUSA U2V GROUND MOUNT
 20 DEGREE TILT ANGLE
 PORTRAIT MODULE ORIENTATION
 30 MODULES**

4

4

3

3

2

2

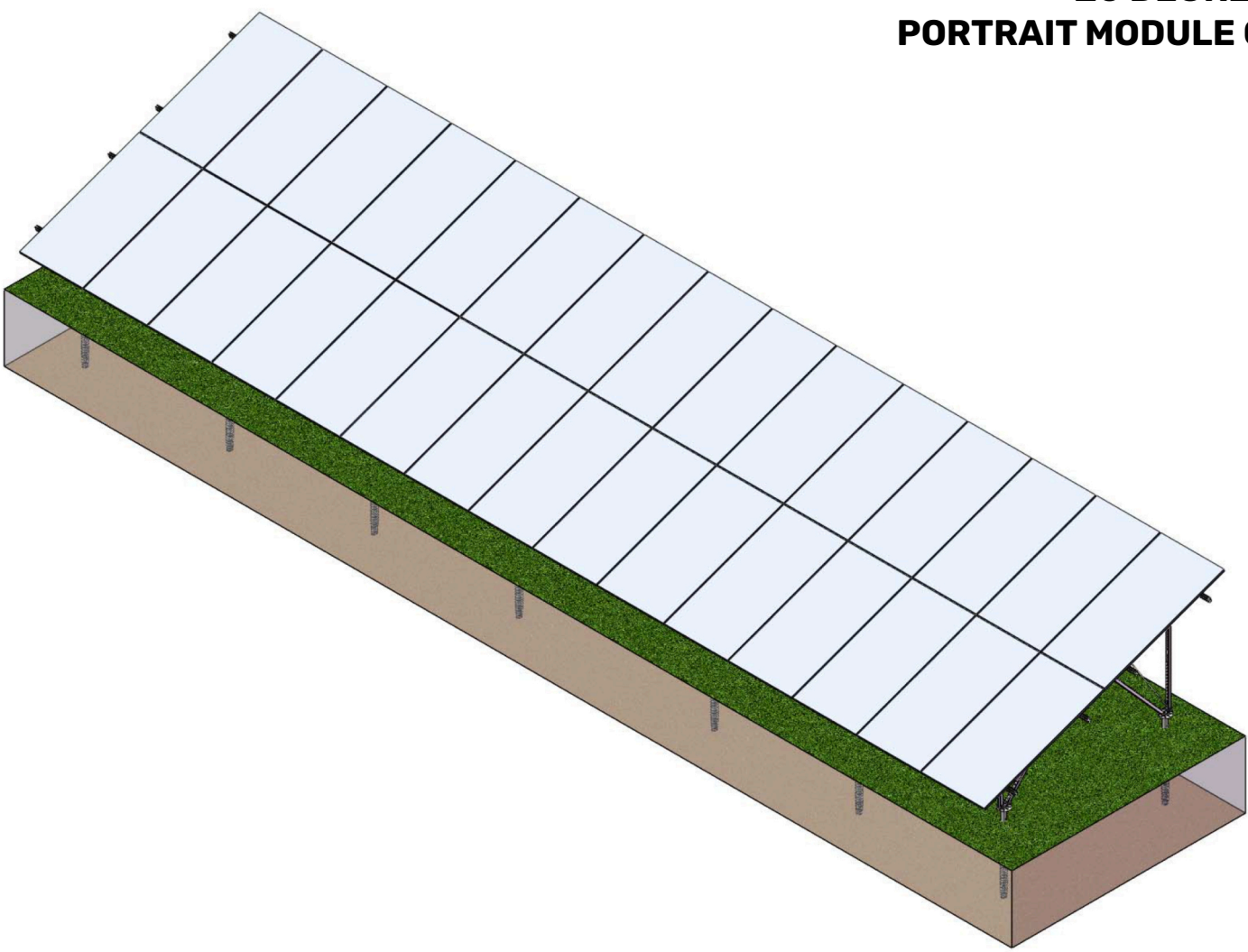

1

1

Mark	Modifivation	Modify by	Doc No.	Data	Des	J. Burton	240918
					Drw		
					Check		
					Craft		
					App		

CHIKOUSA

U2V

2x15 20°

View :

Rate

Page 1

A

B

C

D

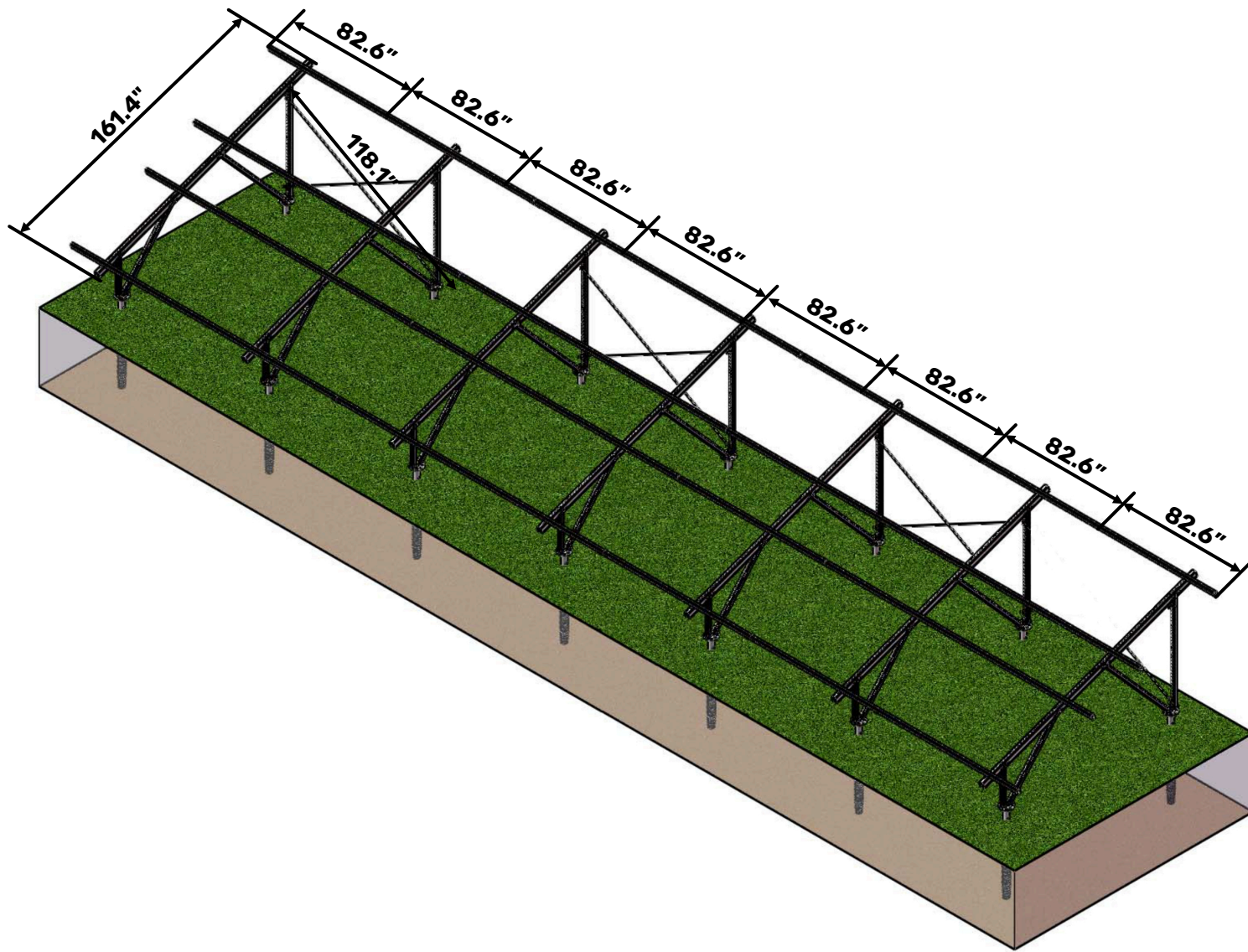

1	Mark	Modifivation	Modify by	Doc No.	Data	Des	J. Burton	240918
						Drw		
						Check		
						Craft		
						App		

CHIKOUSA

U2V

2x15 20°

View : 

Rate

Page 2

A

B

C

D

No	Description
1	Support Rack
2	End Clamp
3	Mid Clamp
4	Rail Splice Kit
5	Rail-4150
6	Strengthen Fix Kit
7	Strengthen Pipe
8	Ground Screw

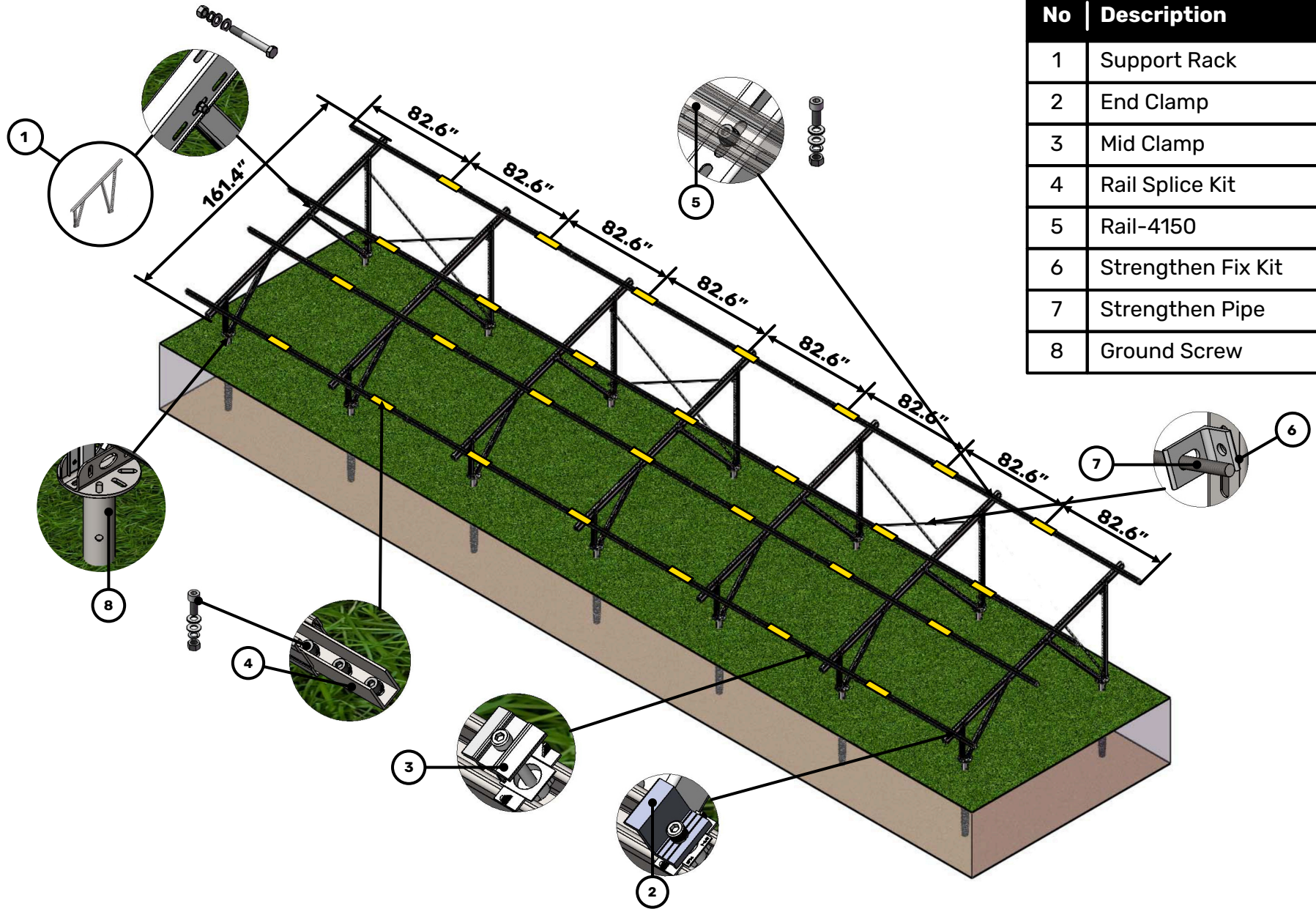

1	Mark	Modifivation	Modify by	Doc No.	Data	Des	J. Burton	240918
						Drw		
						Check		
						Craft		
						App		

CHIKOUSA

U2V

2x15 20°

View:

Rate

Page 3

A

B

C

D

A

B

C

D

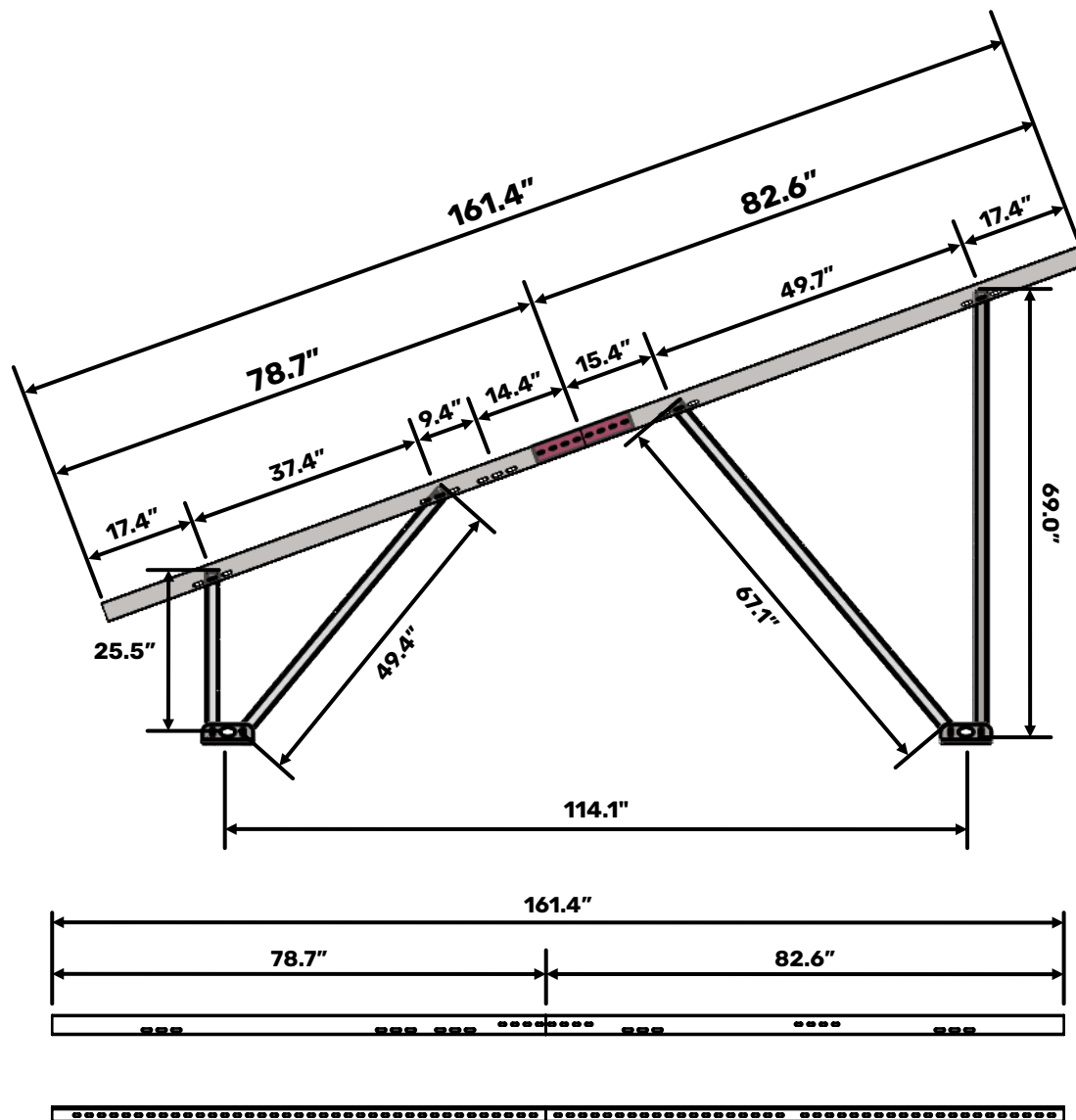

4

4

3

3

2

2

1

1

Mark	Modifivation	Modify by	Doc No.	Data	Des		
					Drw		
					Check		
					Craft		
					App		

CHIKOUSA

View :

Rate

Page 4

A

B

C

D

A

B

C

D

Attachment Distance

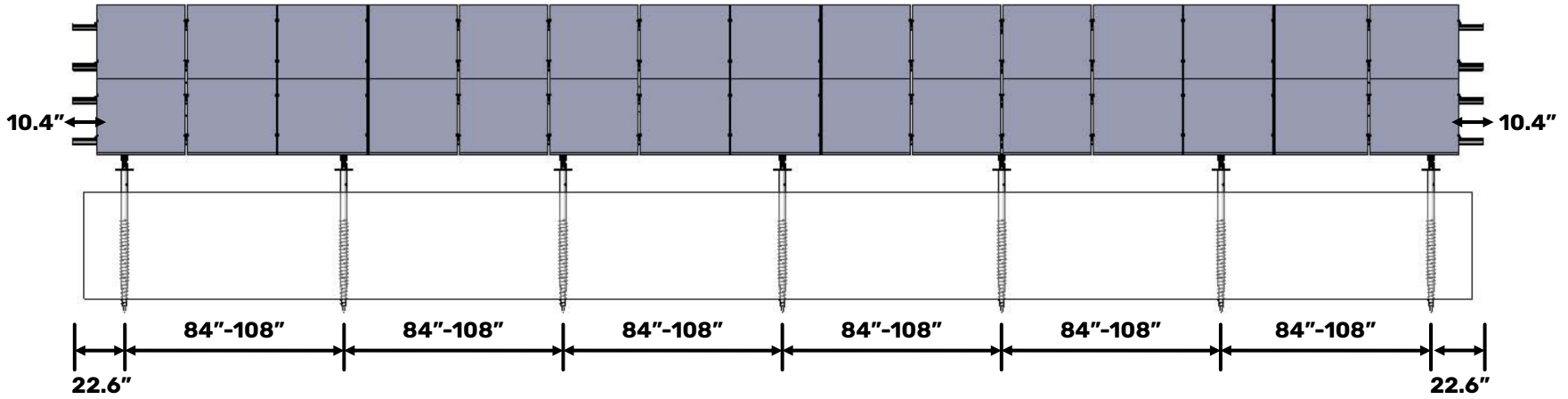

Rail Length

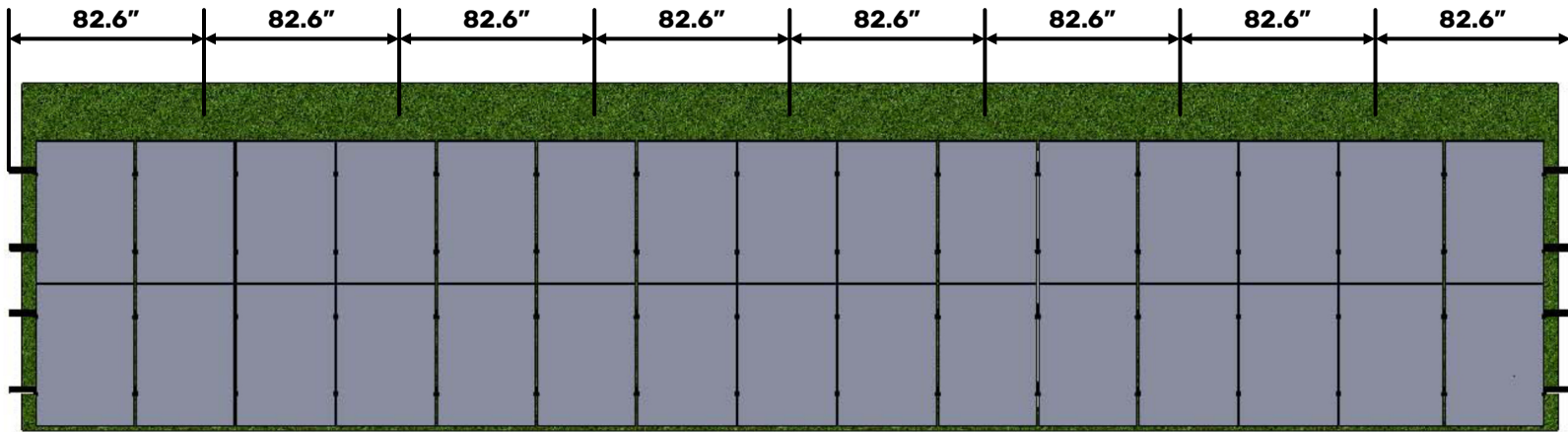

1	Mark	Modifivation	Modify by	Doc No.	Data	Des	J. Burton	240918
						Drw		
						Check		
						Craft		
						App		

CHIKOUSA

U2V

2x15 20°

View :

Rate

Page 5

A

B

C

D