

EG4[®] LIFEPOWER4 24V V2 SERVER RACK

CONNECTIONS OVERVIEW & PARALLELING GUIDE



TABLE OF CONTENTS

1.	TECHNICAL SPECIFICATIONS	1
2.	BATTERY SAFETY	3
2.1	SAFETY INSTRUCTIONS.....	3
2.2	IMPORTANT SAFETY NOTIFICATIONS.....	3
3.	FRONT PANEL CALLOUTS	5
3.1	BATTERY DIAGRAM	5
3.2	LED INDICATOR STATUS & DEFINITION.....	6
3.3	PRE-WIRE STEPS AND WIRING	7
3.4	MULTIMETER TESTING AND WIRING	7
4.	EXAMPLE CONNECTION CONFIGURATIONS.....	8
5.	BATTERY COMMUNICATIONS.....	9
5.1	COMMUNICATION CABLE PINOUT AND DIP SWITCH ID TABLES.....	9
5.2	MULTIPLE BATTERY PARALLEL INSTALL	11
6.	EG4 10-YEAR LIMITED WARRANTY.....	13

1. TECHNICAL SPECIFICATIONS

MODULE OPERATING PARAMETERS			
PARAMETER	BMS	RECOMMENDED	
VOLTAGE	25.6V	-	
CAPACITY	200Ah	-	
CHARGING VOLTAGE (BULK/ABSORB)	28.0 ± 0.4V	-	
SOC CUTOFF	22.4V	20%*	
CHARGING CURRENT	200A (Max. continuous)	100A	
DISCHARGING CURRENT	200A (Max. continuous)	-	
MAXIMUM CONTINUOUS DISCHARGE RATE	5.12kW	-	
NAMEPLATE ENERGY CAPACITY	5.12kWh	-	
BMS PARAMETERS			
CHARGE	SPEC	DELAY	RECOVERY
CELL VOLTAGE PROTECTION	3.8V	1 sec	3.45V
MODULE VOLTAGE PROTECTION	30.0V	1 sec	27.6V
OVER CHARGING CURRENT 1	>220A	10 sec	-
OVER CHARGING CURRENT 2	≥250A	3 sec	-
TEMPERATURE PROTECTION	<23°F or >158°F <-5°C or >70°C	1 sec	>41°F or <140°F >5°C or <60°C
DISCHARGE			
CELL VOLTAGE PROTECTION	2.3V	1 sec	3.1V
MODULE VOLTAGE PROTECTION	22.4V	1 sec	24.0V
OVER CHARGING CURRENT 1	>220A	30 sec	60 sec
OVER CHARGING CURRENT 2	>300A	5 sec	60 sec
SHORT-CIRCUIT	>500A	<0.1 mS	-
TEMPERATURE PROTECTION	<-4°F or >167°F <-20°C or >75°C	1 sec	>14°F or <149°F >-10°C or <65°C
PCB TEMP PROTECTION	>221°F (>105°C)	1 sec	<176°F (<80°C)

*EG4 recommends this value be set no lower than 20% to maintain the recommended 80% depth of discharge.

GENERAL SPECIFICATIONS			
PARAMETER	SPEC	TYPE	CONDITION
CELL BALANCE	120mA	Passive Balance	Cell Voltage Difference >40mV
TEMPERATURE ACCURACY	3%	Cycle Measurement	Measuring Range 40°F – 212°F (-40°C – 100°C)
VOLTAGE ACCURACY	0.5%	Cycle Measurement	For Cells/Module
CURRENT ACCURACY	3%	Cycle Measurement	Measurement Range +/-200A
SOC	5%	-	Integral Calculation
POWER CONSUMPTION (SLEEP & OFF MODE)	<300uA	-	Storage/Transport/Standby
POWER CONSUMPTION (OPERATING)	<20mA	-	Charging/Discharging
COMMUNICATION PORTS	RS485/CAN	-	Customizable
MAXIMUM MODULES IN SERIES		1	
MAXIMUM MODULES IN PARALLEL		64	
DIMENSION (H×W×D)	6.1×19×17.4 in. (155×442×470 mm)		
WEIGHT	99.2 lbs. (45 kg)		
ENVIRONMENTAL PARAMETERS			
CHARGING RANGE	32°F – 113°F (0°C – 45°C)		
DISCHARGING RANGE	-4°F – 122°F (-20°C – 50°C)		
STORAGE RANGE	-4°F – 122°F (-20°C – 50°C)		
INGRESS PROTECTION	IP21		

2. BATTERY SAFETY

2.1 SAFETY INSTRUCTIONS

Before any work begins, carefully read all safety instructions, and always observe them when working on or with the battery. The installation must follow all applicable national or local standards and regulations. Consult with the local AHJ to obtain the proper permits and permissions before installation.

Incorrect installation may cause:

- *Injury or death to the installer, operator or third party*
- *Damage to the battery or other attached equipment*

2.2 IMPORTANT SAFETY NOTIFICATIONS



DANGER: Hazardous Voltage Circuits!
AVERTISSEMENT! Circuits à tension élevée!

There are various safety concerns that must be carefully observed before, during, and after the installation, as well as during future operation and maintenance. The following are important safety notifications for the installer and any end users of this product under normal operating conditions.

1. **Do not disassemble the battery.** Contact the distributor for any issues that need repair for more information and proper handling instructions. Incorrect servicing or re-assembly may result in a risk of electric shock or fire and void the warranty.
2. **Never short-circuit DC inputs.** Short-circuiting the battery may result in a risk of electric shock or fire and can lead to severe injury or death and/or permanent damage to the unit and/or any connected equipment.
3. **Use caution when working with metal tools on or around batteries and systems.** **Risk** of electrical arcs and/or short circuiting of equipment can lead to severe injury or death and equipment damage.
4. **Beware of high battery current.** Ensure that the battery module breakers and/or on/off switches are in the “open” or “off” position before installing or working on the battery. Use a voltmeter to confirm there is no voltage present to avoid electric shock.
5. **Do not make any connections or disconnections to the system while the batteries are operating.** Damage to system components or risk of electrical shock may occur if working with energized batteries.
6. Make sure the battery and rack are properly grounded.
7. An installer should make sure to be well protected by reasonable and professional insulative equipment [e.g., personal protective equipment (PPE)].
8. Before installing, operating, or maintaining the system, it is important to inspect all existing wiring to ensure it meets the appropriate specifications and conditions for use.
9. Ensure that the battery and system component connections are secure and proper to prevent damage or injuries caused by improper installation.



WARNING: TO REDUCE THE RISK OF INJURY, READ ALL INSTRUCTIONS!

All work on this product (system design, installation, operation, setting, configuration, and maintenance) must be carried out by qualified personnel. To reduce the risk of electric shock, do not perform any servicing other than those specified in the operating instructions unless qualified to do so.

1. Read all instructions before commencing installation. For electrical work, follow all local and national wiring standards, regulations, and these installation instructions. All wiring should be in accordance with the National Electrical Code (NEC), ANSI/NFPA 70.
2. The battery and system can connect with the utility grid only if the utility provider permits. Consult with the local AHJ before installing this product for any additional regulations and requirements for the area.
3. All warning labels and nameplates on this battery should be clearly visible and must not be removed or covered.
4. The installer should consider the safety of future users when choosing the battery's correct position and location as specified in this manual.
5. Please keep children away from touching or misusing the battery and relevant systems.

The battery is designed to stop charging when reaching the low threshold of 32°F. If charging current is observed when the internal battery temperature is below 32°F, disconnect battery immediately and consult distributor.

DISCLAIMER

EG4 reserves the right to make changes to the material herein at any time without notice.

Please refer to www.eg4electronics.com for the most updated version of our manuals/spec sheets.

3. FRONT PANEL CALLOUTS

3.1 BATTERY DIAGRAM

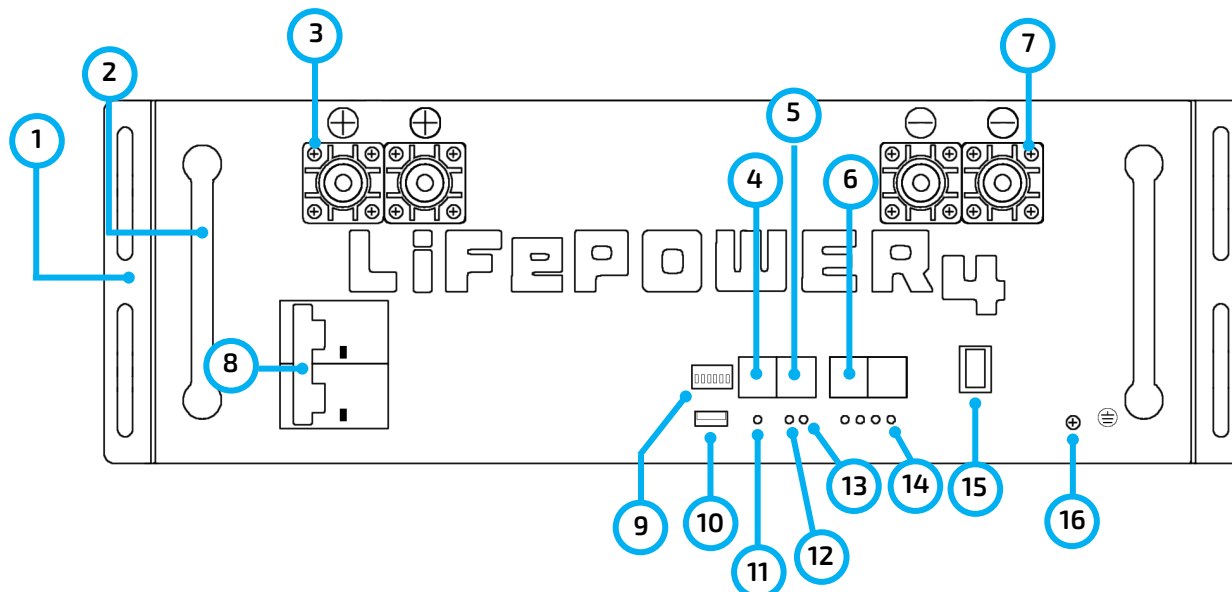

NO.	ITEM	DESCRIPTION	REMARKS
1	Rack mount ear	For battery rack mounting	Secures the battery to the rack
2	Handle	For carrying/handling battery	-
3	Positive terminal	M8 bolt (x2)	-
4	CAN	CAN communication interface	Pin 4 – CAN_H Pin 5 – CAN_L
5	RS485	RS485 communication interface	Pin 1 & Pin 8 – RS485B Pin 2 & Pin 7 – RS485A
6	Battery Communications	Parallel battery communication port	Used for closed-loop communication
7	Negative terminal	M8 bolt (x2)	-
8	Breaker	Circuit breaker	DC output
9	Battery ID DIP Switch	ID for battery arrangement	6 position DIP switch, can support 64 in parallel
10	USB Port	Reserved	-
11	Reset	Emergency Reset	-
12	ALM	Alarm LED Display	-
13	RUN	Run LED Display	-
14	SOC	State Of Charge Display	LEDs indicate charge level
15	ON/OFF Switch	Turn BMS on/off	-
16	GND	Ground connection for safety	-

3.2 LED INDICATOR STATUS & DEFINITION

STATUS	NORMAL/ ALARM/ PROTECTION	RUN	ALM	SOC INDICATE LED	NOTES	
		●	●			
Shutdown/Sleep		OFF	OFF	OFF	-	
Stand-by	Normal	ON	OFF	Based on battery indicator (Each LED indicates 25% SOC)	-	
	Alarm	ON	FLASH		According to the state before stand-by	
Charge	Normal	Short flash	OFF		-	
	Alarm	Short flash	Short flash		-	
	End-off Voltage	OFF	ON		-	
	Over-Temp Protection	OFF	Short flash		-	
	Over-current transfer limit protection	Short flash	Short flash/OFF		-	
Discharge	Normal	Long flash	OFF		Based on battery indicator	-
	Alarm	Long flash	Long flash			-
	End-off Voltage	OFF	OFF			Standby
	Over-Temp/ Over-current Protection	OFF	ON	-		
BMS Fault	-	OFF	Flash	All OFF	-	

***NOTE:** Below are two images of the SOC LED and what each LED represents.

NO	SOC %
1	25%
2	50%
3	75%
4	100%

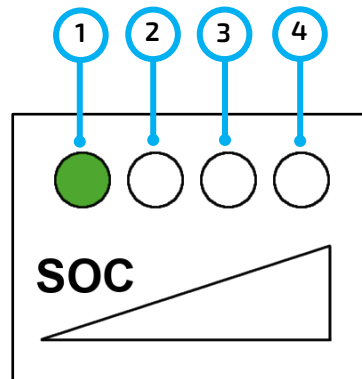

3.3 PRE-WIRE STEPS AND WIRING

The battery will come with 1 set of 2 AWG power cables. Please refer to the inverter documentation that the battery will be connected to for torque specs and wire sizing needs for specific use cases. Where ambient temperature is above 86°F (30°C), cable size must be increased according to NEC 310. The 2 AWG cable included in the package is intended only for the connection from the module to an EG4® battery rack busbar.



DANGER:

No connections should be made until the proper polarity of the cables have been confirmed between the battery and inverter!

3.4 MULTIMETER TESTING AND WIRING

Follow the steps outlined below to both test the inputs and wire the battery to the system. Refer to the system's user manual for specific torque values. If using non-EG4® inverters, refer to the appropriate manufacturer user manual.



CAUTION:

The battery can charge/discharge up to 200A before the BMS will shut it off. Ensure the inverter is configured to handle this high of a current and size all wires according to an NEC approved ampacity chart. Consult with the installer or a solar electrician for more information.

1. Ensure all circuit breakers in the system are open (off). Using a multimeter, check for voltage at all available disconnects and lines. Once no voltage is confirmed, proceed to the next step.
2. Connect the included set of 2 AWG to the battery's positive and negative terminals, respectively.
3. If applicable, route the battery power cables through the conduit box to the inverter before making any connections!
4. Ensure proper polarity of cables. Once confirmed, proceed to the next step.
5. Install the positive battery cable to the inverter's positive battery terminals following proper torque values.
6. Install the negative battery cable to the inverter's negative battery terminals following proper torque values.

4. EXAMPLE CONNECTION CONFIGURATIONS



NOTE:

The image below represents 6 EG4® LifePower4 24V V2 batteries installed in an EG4 Indoor Cabinet. When installing multiple batteries or adding a battery to an existing rack, please ensure each battery is charged individually to 100% before paralleling them together. This step is crucial to optimize battery performance and ensure proper operation.

1. Insert the battery into the rack slot, beginning with the bottom slot and progressing upward. Slide in until the battery is firmly seated in the rack.
2. **Use the included 2 AWG power cable to connect each battery to the busbar.**
3. **DO NOT** finger tighten the battery or busbar terminal bolts. The battery bolts require a certain torque [60 in-lbs. (6.8Nm)] to ensure they do not loosen during operation. Failure to properly tighten the terminal bolts can result in serious damage and will void the warranty.
4. Clearly identify the location of the batteries positive and negative terminals—red to the positive terminal and black to the negative terminal. Once identified, connect to the inverter's positive and negative terminals.

Grounding

Attach a grounding wire from the rack/cabinet to an equipment grounding conductor, then terminate the EGC at a grounding electrode.



WARNING:

Do not ground rack/cabinet or door to negative or positive bus bars!

In this image, there are 6 EG4 LifePower4 V2 200Ah batteries wired in parallel. This battery bank still maintains the appropriate 24V needed for a system. However, the amp hour rating of this bank increases to 1200Ah. In addition, the potential output amperage of the rack has increased.



NOTE:

Use the included battery cables or size the battery cables appropriately! Refer to an NEC approved ampacity chart for specifications.



NOTE:

EG4 recommends using a properly sized (amp rated) busbar to parallel batteries together. Paralleling via the battery terminals will cause inconsistent charging and discharging issues in the bank.

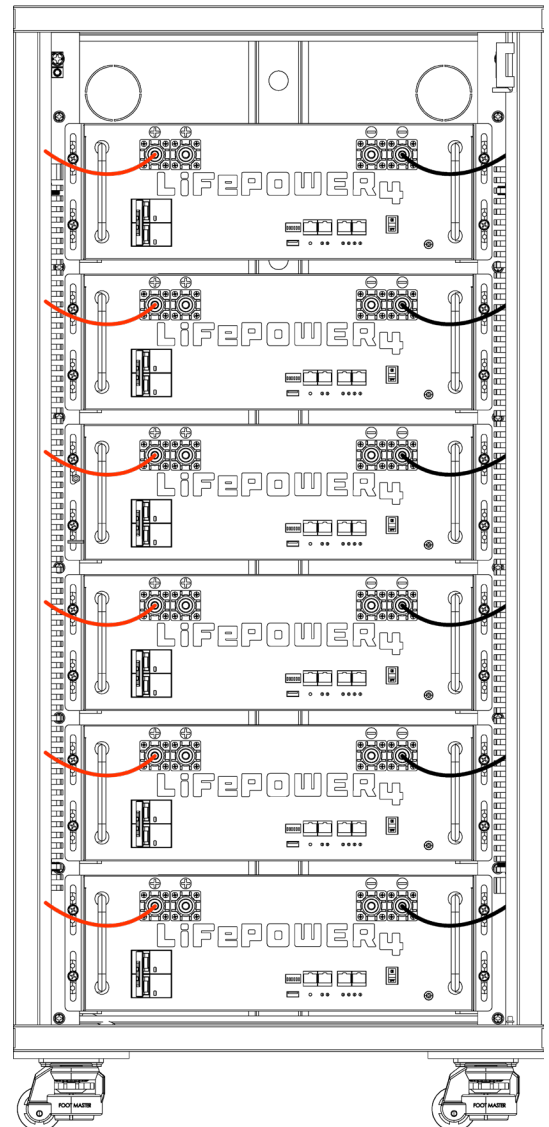

5. BATTERY COMMUNICATIONS

Each EG4® battery is designed with the end-user in mind, displaying detailed information in the simplest manner possible. EG4 Electronics includes the option of connecting the battery to PC software to monitor the module status, allowing the user to know exactly what the battery is doing and troubleshoot any problems that may arise.

For more information on battery to PC monitoring using BMS Tools, refer to “Device & Monitoring Guide” by scanning the QR code below.



WARNING:

Make sure to install the communication cables into their respective ports! Improper installation may lead to component damage! EG4 recommends double checking all points of connection before introducing power to the system to mitigate any potential issues.



NOTE:

The short communications cable that connects from battery to battery is a standard CAT5 cable with a straight through pinout. If the battery to inverter communications cable is not long enough to span the distance from inverter to master battery, refer to the communication cable pinout table in the following section.

5.1 COMMUNICATION CABLE PINOUT AND DIP SWITCH ID TABLES

EG4® LifePower4 24V V2 batteries can support up to 64 modules in parallel, each with their own DIP switch configuration. The batteries interface with the inverter by designating a “Host” battery (DIP switch ID No. 1) with each subsequent battery using sequential configurations.

















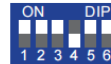



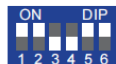

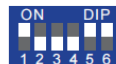

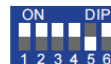
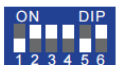





































For Victron communication cables, contact the distributor.



PIN*	DESCRIPTION
1	RS485B
2	RS485A
3	CAN Ground (optional)
4	CAN High
5	CAN Low

***Pinouts are for battery side; please refer to the system manual for pinout configuration on system end**

DIP switch ID table – 6 Pin

 ID:1	 ID:2	 ID:3	 ID:4	 ID:5	 ID:6	 ID:7	 ID:8
 ID:9	 ID:10	 ID:11	 ID:12	 ID:13	 ID:14	 ID:15	 ID:16
 ID:17	 ID:18	 ID:19	 ID:20	 ID:21	 ID:22	 ID:23	 ID:24
 ID:25	 ID:26	 ID:27	 ID:28	 ID:29	 ID:30	 ID:31	 ID:32
 ID:33	 ID:34	 ID:35	 ID:36	 ID:37	 ID:38	 ID:39	 ID:40
 ID:41	 ID:42	 ID:43	 ID:44	 ID:45	 ID:46	 ID:47	 ID:48
 ID:49	 ID:50	 ID:51	 ID:52	 ID:53	 ID:54	 ID:55	 ID:56
 ID:57	 ID:58	 ID:59	 ID:60	 ID:61	 ID:62	 ID:63	 ID:64



REMINDER:

When paralleling multiple batteries, all DIP switch settings must be different from each other. This allows all equipment to see each battery in the bank separately.

EG4 recommends addressing the batteries in ascending order.

5.2 MULTIPLE BATTERY PARALLEL INSTALL



NOTE:

When installing multiple batteries or adding a battery to an existing rack, please ensure all batteries are charged to 100% before paralleling together. This step is crucial to optimize battery performance and ensure proper operation.

Follow the steps outlined below to ensure proper installation of multiple batteries in parallel.

1. Ensure all circuit breakers are open (off). Using a multimeter, check for voltage at all available disconnects and lines. Once no voltage is confirmed, proceed to the next step.
2. Set the DIP switch address on the master battery to address 1, and all other batteries in parallel to differing addresses going in ascending order. (See image) →
3. Reset the battery BMS via the power button to register the address change.
4. Set up communication between the batteries via the “Battery-Comm” ports by using a CAT 5, 5e, or 6 cable.

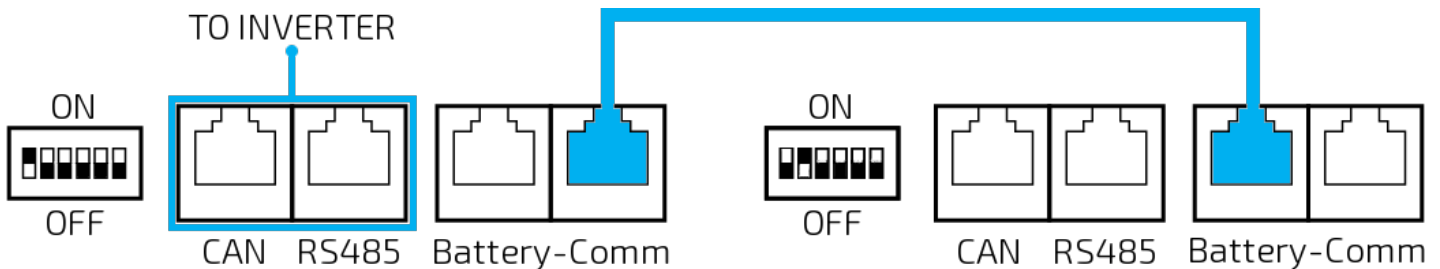

5. The battery set to address 1 will connect directly to the inverter BMS communication port via CAT 5, 5e or CAT 6 cable.

The image to the right shows a representation of the dip switch. The white represents the switches and how they should be set. →

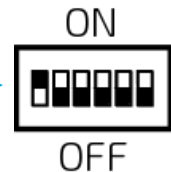

For additional examples of paralleling batteries, refer to the next page.



REMINDER:

The battery can charge/discharge up to 200A before the BMS shuts off the pack. Ensure the inverter is configured to handle this high of a current and size all wires accordingly! Refer to an NEC approved ampacity chart or consult with the installer or a solar electrician for more information.

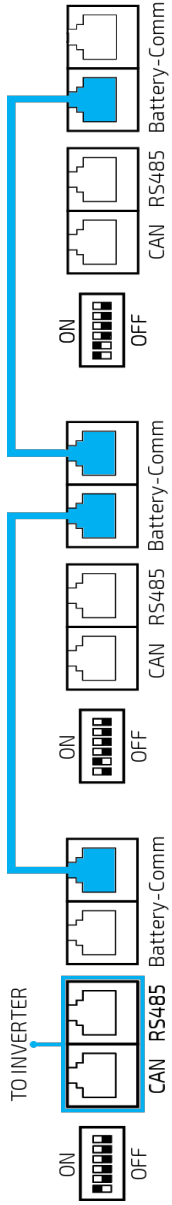

LifePower4 24V V2 in parallel

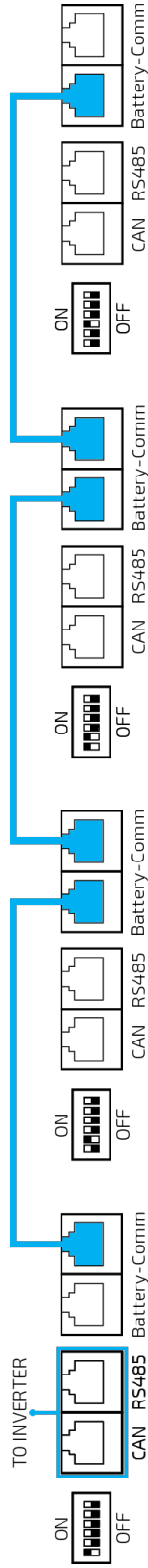

LifePower4 24V V2 in parallel

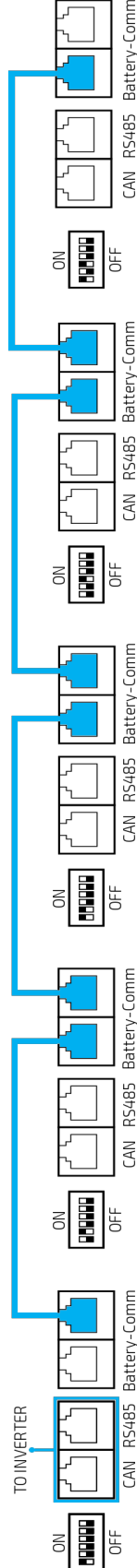

LifePower4 24V V2 in parallel

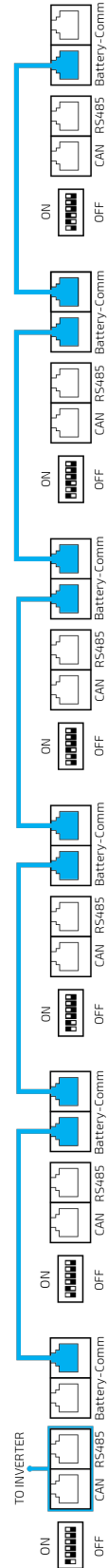

LifePower4 24V V2 in parallel

6. EG4 10-YEAR LIMITED WARRANTY

Congratulations on your purchase. EG4 Electronics offers a 10-year Full Parts Replacement or Full Product Replacement Prorated Warranty from the date of battery (EG4 LifePower4 v2*1) purchase. Your warranty must be registered within the first year of purchase or provide proof of purchase from an EG4 authorized distributor to remain valid. If you choose not to register or cannot provide proof of purchase, your warranty may be invalidated. This limited warranty is to the original purchaser of the product and is one time transferable only if the product remains installed in the original installation location. All parts exchanges, including BMS, are covered during the warranty period. If a full replacement warranty is needed, the warranty is prorated 1/10th per year after the first year at the current retail pricing. Replacement shipping charges may incur on a case-by-case basis. Outside of the continental US, replacement shipping charges may apply.

Product that is not purchased through an EG4 approved vendor is not covered under this warranty. A list of approved vendors can be found on our website. Reselling or removing the product from the original installation site will void the warranty.

Warranty Exclusions - EG4 Electronics has no obligation under this limited warranty for products subjected to the following conditions (including but not limited to):

- Damages incurred during installation/reinstallation or removal
- Poor workmanship performed by an individual, installer, or a firm
- Damages caused by mishandling the product or inappropriate environmental exposure
- Damages caused by improper maintenance or operating outside the specified operating conditions
- Tampering, altering, and/or disassembly of the product
- Using product in applications other than what the manufacturer intended
- Lightning, fire, flood, earthquake, terrorism, riots, or acts of God
- Any product with a serial number that has been altered, defaced, or removed
- Any unauthorized firmware updates/upgrades/patches
- Damages incurred from a voltage or current spikes due to open-loop lithium battery communications

EG4 product warranty is a **limited warranty** – EG4 limits its liability in the event of a product defect to repair or replacement in accordance with the terms of this limited warranty. EG4 is not responsible for any additional or indirect damages that may arise from the malfunctioning of the product. These damages could be incidental or consequential, including without limitation, any liability for the loss of revenue, profits, or time. EG4 shall not be liable for any direct or indirect loss of life, including but not limited to bodily injury, illness, or death arising from the misuse or mishandling of the product, whether caused by negligence or otherwise.

Return Policy and Warranty Claims Procedure: Contact your original place of purchase.

*1 Covers: EG4 LifePower4 48V v2 | Model #: SR-48-100-LP4-IN-02
EG4 LifePower4 24V v2 | Model #: SR-24-200-LP4-IN-02

CHANGELOG

Version 1.0

- First version release



CONTACT US

support@eg4electronics.com

(903) 609-1988

www.eg4electronics.com